



Instruction Manual

LX85 Series with AudioStar German Equatorial Mounted Telescopes





WARNING!

Never use an unfiltered telescope to look at the Sun! Looking at or near the Sun will cause instant and irreversible damage to your eye. Eye damage is often painless, so there is no warning to the observer that damage has occurred until it is too late. Do not point the telescope at or near the Sun. Do not look through the telescope or Viewfinder as it is moving. Children should always have adult supervision while observing.

CONTENTS

LX85 Mount Overview	4
ACF Optical Tube Overview	8
Mak-Cass Optical Tube Overview	9
Reflector Optical Tube Overview	10
Refractor Optical Tube Overview	11
Parts List	12
Assembly	
Assembling the Tripod	14
Attaching the LX85 Mount to the Tripod	14
Setting the Latitude	14
Attaching the Accessory Tray	15
Attaching the Counterweight & Shaft	15
Installing the AudioStar and Cables	15
Installing the Telescope Optical Tube	15
Installing the Accessories	16
Balancing the LX85	16
The Telescope Home Position	17
Aligning the Finder Scope	17
Polar Alignment	18
Operating the LX85	
Powering the LX85	19
Moving Through AudioStar's Menus	19
Initializing AudioStar	19
Easy Alignment with AudioStar	20
Go To Your First Object	21
Using the Guided Tour	21
The AudioStar Handbook	22
Tour the Cosmos with Just the Push of a Button	22
Observing Using AudioStar's Arrow Keys	24
Observe the Moon	25
Terrestrial Observing	25
AudioStar Operation	26
AudioStar Navigation Exercise	26
Entering Data into AudioStar	27
Entering Data into AudioStar	27
Guided Tour Menu	27
Object Menu	27
The AudioStar Menu Tree	28
Event Menu	29
Glossary Menu	30
Utilities Menu	30
Setup Menu	31
Periodic Error Correction (PEC) Training	33
PEC Train Menu Option	33
PEC Update Menu Option	34
PEC Erase Menu Option	34
PEC On and Off Menu Options	34

Appendix A:	
Specifications	35
Appendix B:	
Advanced Polar Alignment	45
Celestial Coordinates	45
Alternative Polar Alignments with AudioStar	45
Appendix C:	
General Maintenance	48
Appendix D:	
Training the Drive	49
Appendix E:	
Advanced Coma-Free Optical System	50
Maksutov-Cassegrain Optical System	50
Refractor Optical System	51
Reflector Optical System	51
Appendix F	
Collimating the Optics	52
Collimating the Maksutov-Cassegrain	52
Collimating the ACF	52
Collimating the Newtonian Reflector	54
Appendix G	
Table of Latitudes	57
Recycling Information	
Waste Electrical & Electronic Equipment	58
Meade Limited Warranty	59
Contact Information	
Social Media and Address	Back Cover

LX85 Mount Overview

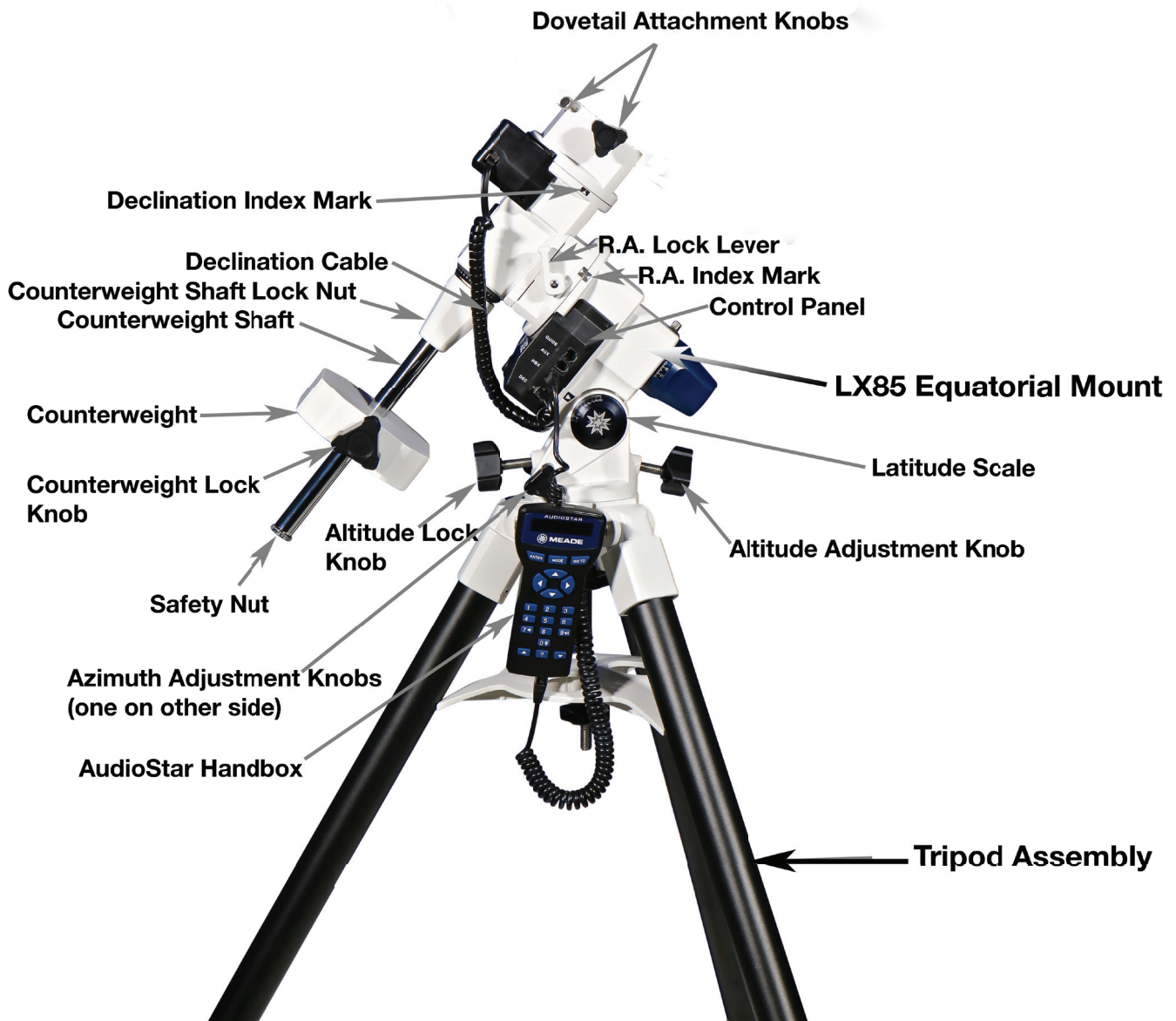

LX85 Mount Overview

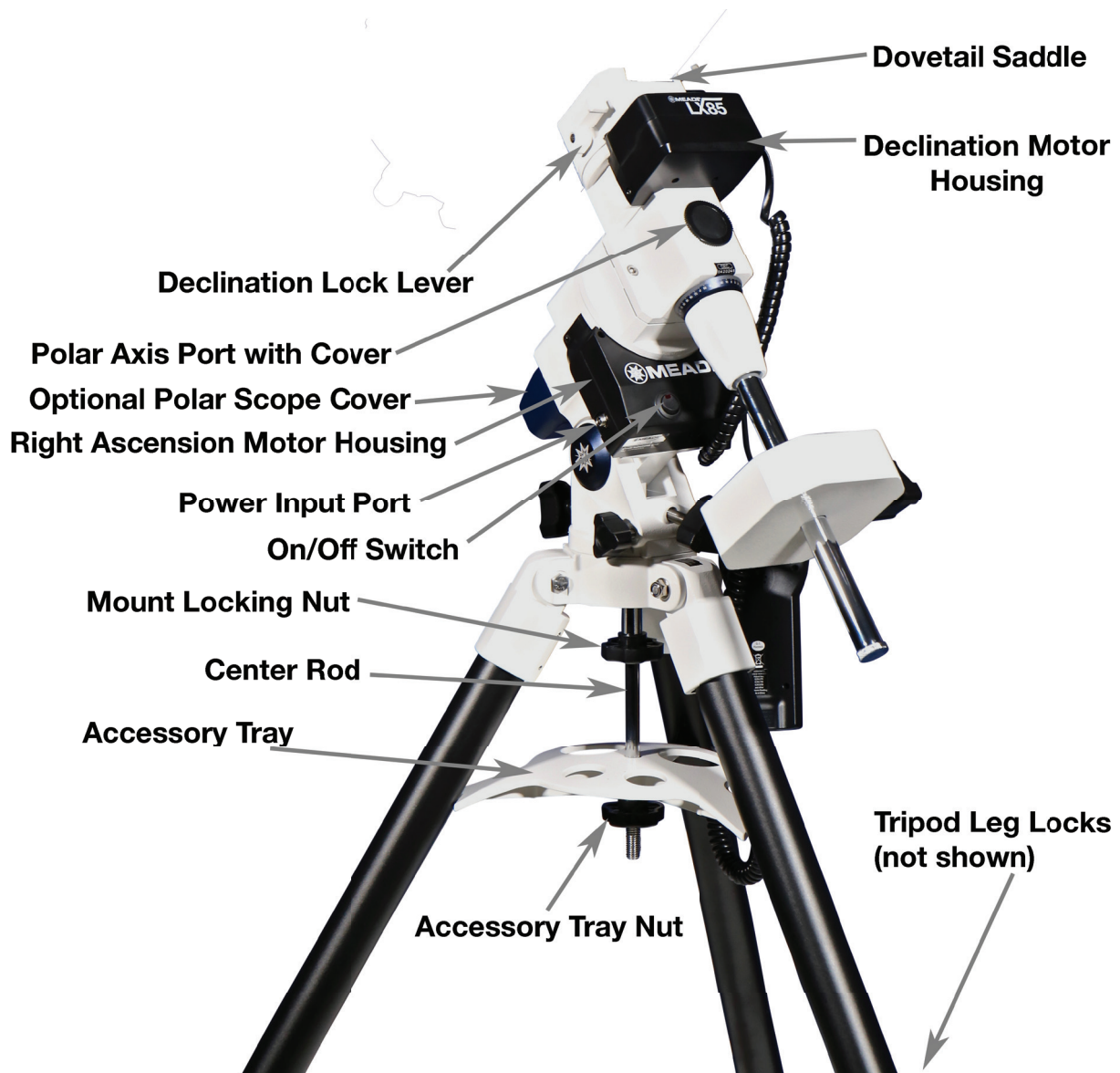

Overview

Tripod Assembly: Supports the weight of your entire telescope assembly. Adjustable height tripod collapses for transport and storage.

LX85 Equatorial Mount: This is the equatorial platform on top of the tripod which holds your telescope and all of its accessories. This is the mechanical component responsible for pointing and tracking. It contains two motors, one for Right Ascension which moves east/west, and one for Declination, which moves north/south.

Optical Tube Assembly (OTA): The optical portion of the telescope which gathers light and focuses distant objects through the eyepiece for observation, or to a camera for astrophotography.

Eyepiece: The optical component that you look through to observe objects in the night sky. Eyepieces are interchangeable. Several varieties are available with a range of magnification and field of view.

Diagonal Mirror (for ACF, Mak-Cass, and Refractors only): Flips the eyepiece position upright for better comfort and accessibility when viewing objects high overhead. The Diagonal Mirror also provides a right-side-up image through the telescope.

Finder Scope: Provides a lower power, wider field of view to help locate bright stars and objects before centering them in the eyepiece of the Optical Tube Assembly. The Finder Scope is especially useful during the AudioStar Alignment procedure, and to quickly locate bright objects such as the Moon and planets.

AudioStar Hand Box: The computer control for the LX85. The AudioStar controls the motors and electronics of the mount, responsible for the GOTO, pointing and tracking.

Altitude Adjustment Knob: Adjusts the altitude angle of the LX85 EQ mount. This angle is set to the latitude of your observing location and must be correctly positioned to polar align the telescope.

Altitude Adjustment Lock Knob: Locks the altitude position in place. This is not a load-bearing screw and is only used to prevent the mount's altitude

position from lifting during transport.

Azimuth Adjustment Knobs: Used during polar alignment of the telescope. Makes fine adjustments to the azimuth (left/right) to locate true north (or south in the Southern Hemisphere).

Control Panel: Contains the HBX port for the AudioStar Hand Box Cable, Declination Port, AutoGuide Port, and Auxiliary Port.

R.A. Index Mark: To indicate the RA home position for the telescope.

Declination Index Mark: To indicate the Declination home position of the telescope.

R.A. Lock Lever: Locks the Right Ascension axis. Must remain locked when using AudioStar to keep alignment.

Declination Lock Lever: Locks the Declination axis. Must remain locked when using AudioStar to keep alignment. When in the locked position, the mounts movements are controlled electronically through the AudioStar Handbox.

Declination Cable: Plugs into the Control panel and Declination Motor Housing.

Dovetail Saddle: Mounting space that accepts the Dovetail Mounting Plate.

Dovetail Mounting Plate: The mounting component that attaches the Optical Tube Assembly to the LX85 Equatorial Mount.

Dovetail Attachment Knobs: Allows attachment of Dovetail Mounting Plate to Dovetail Saddle. Both screws must be firmly tightened to secure the Optical Tube Assembly.

Counterweight Shaft: Threads into the LX85 EQ Mount and holds the Counterweight(s).

Counterweight: Counterbalances the weight of the Optical Tube Assembly and accessories. Keeps the Right Ascension motor drive smooth and accurate when properly balanced.

Counterweight Lock Knob: Tighten firmly to hold the counterweight in place.

Safety Nut: Stops the Counterweight from falling to the ground (or your feet) in the event the Counterweight Lock Knob is not tightened.

Polar Axis Port with Cover: An opening around the R.A. axis which is aimed at the Celestial Pole (north or south) when properly polar aligned. Remove the cap when using the optional Polar Scope, otherwise, keep the cap in place.

12V DC Power Input Port: Accepts 12V DC with at least 5A of current. Accepts tip-positive power plugs with a 5.5mm outside diameter and 2.5mm inside diameter.

On/Off Switch: Turns the mount on and off when connected to a power source.

Center Rod: Threads the LX85 EQ Mount to the Tripod Assembly. Also secures the Accessory Tray.

Accessory Tray: Conveniently holds both 2" and 1.25" eyepieces while also improving the rigidity of the tripod when firmly tightened in place.

Accessory Tray Nut: Secures the Accessory Tray in place. Tighten firmly to keep the tripod extra rigid.

ACF Optical Tube Overview

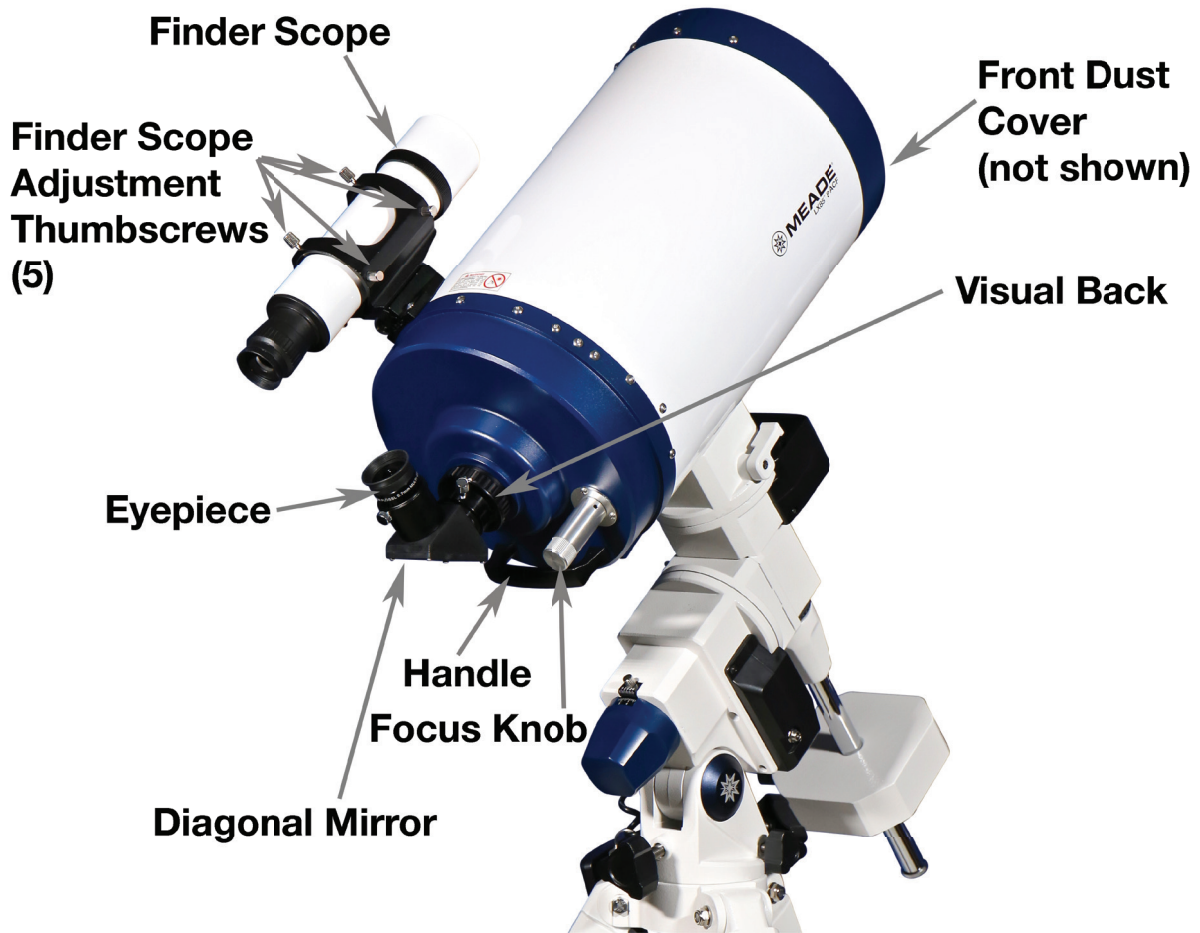

Maksutov-Cassegrain Optical Tube Overview

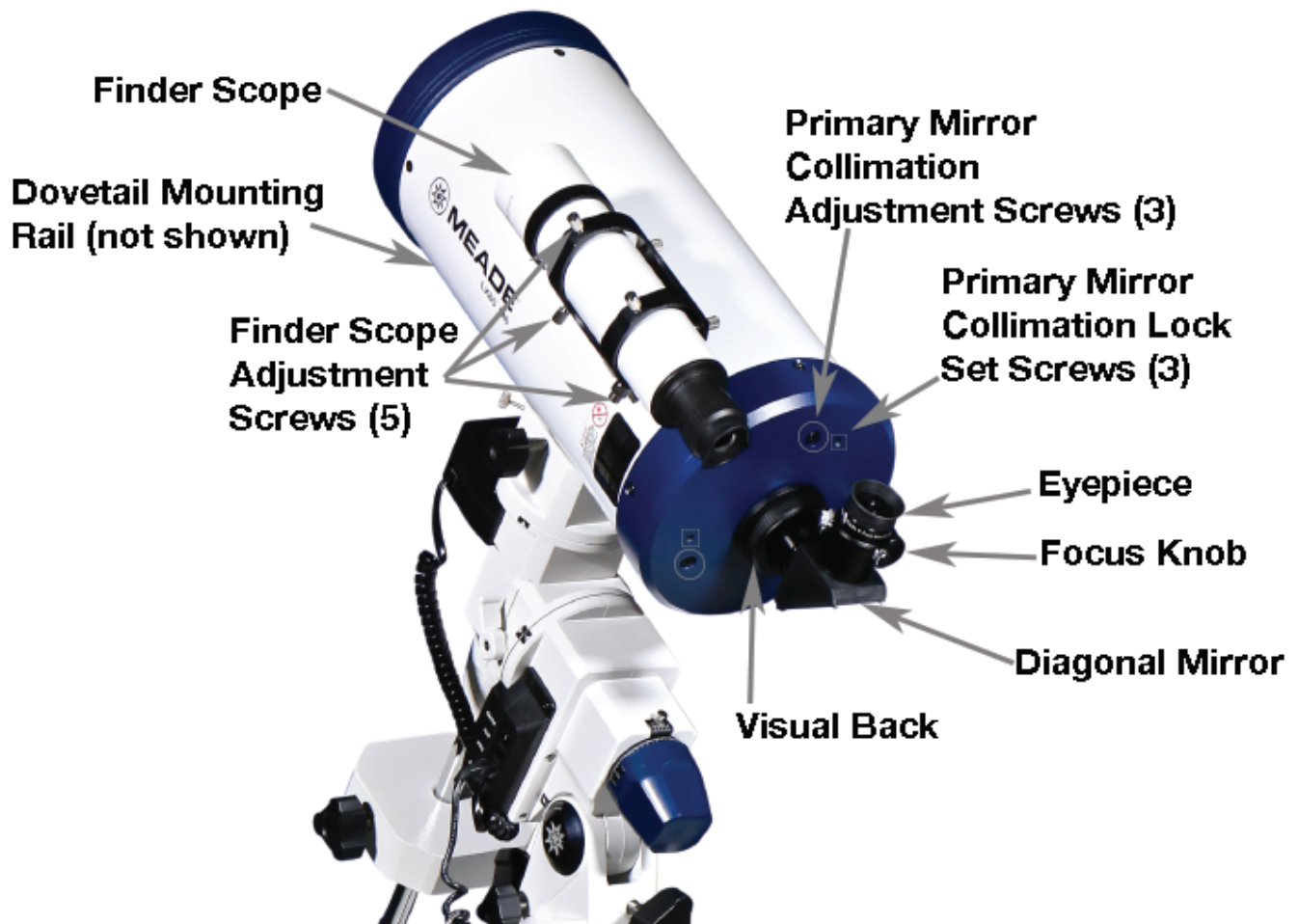

Reflector Optical Tube Overview

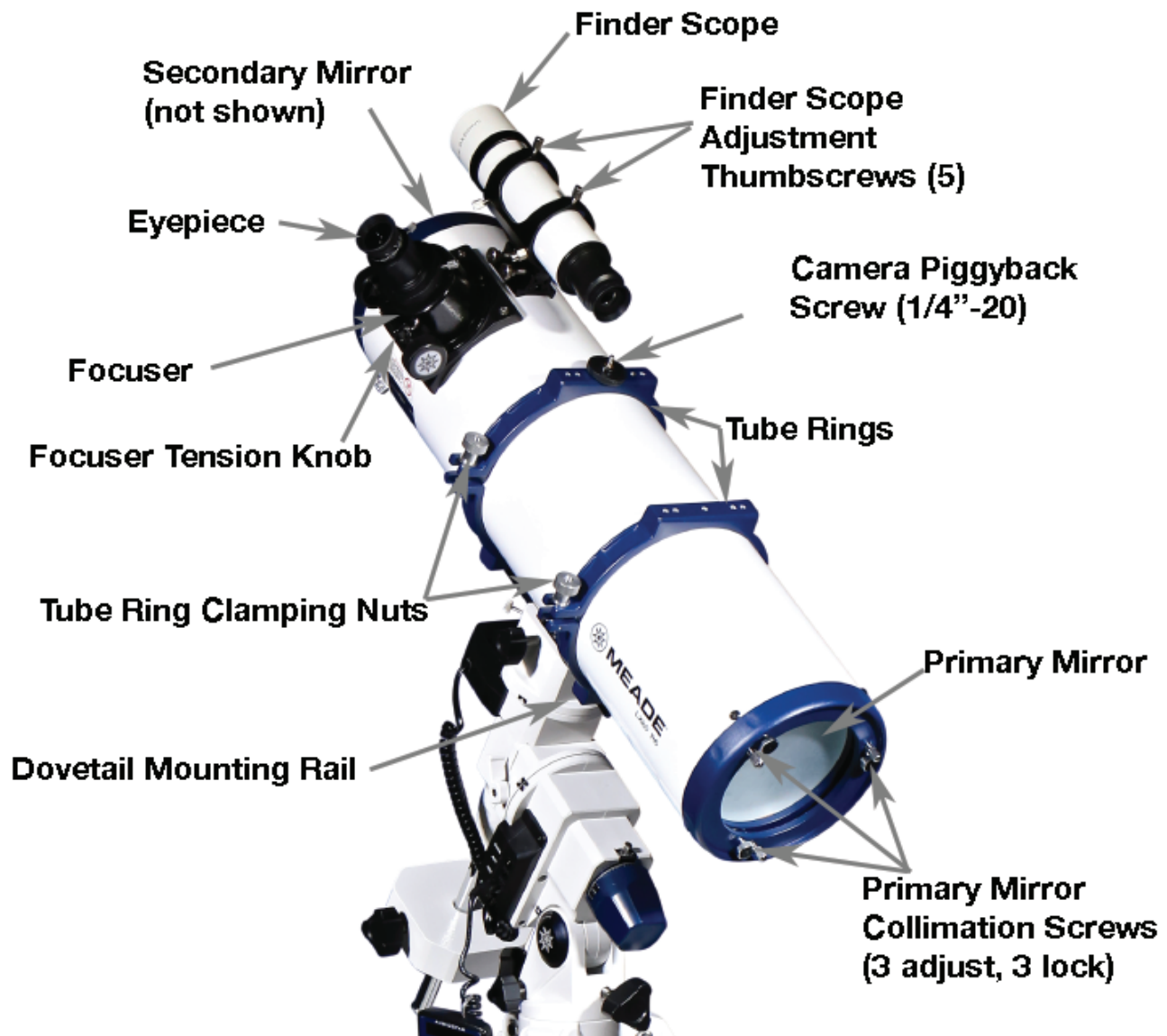

Refractor Optical Tube Overview

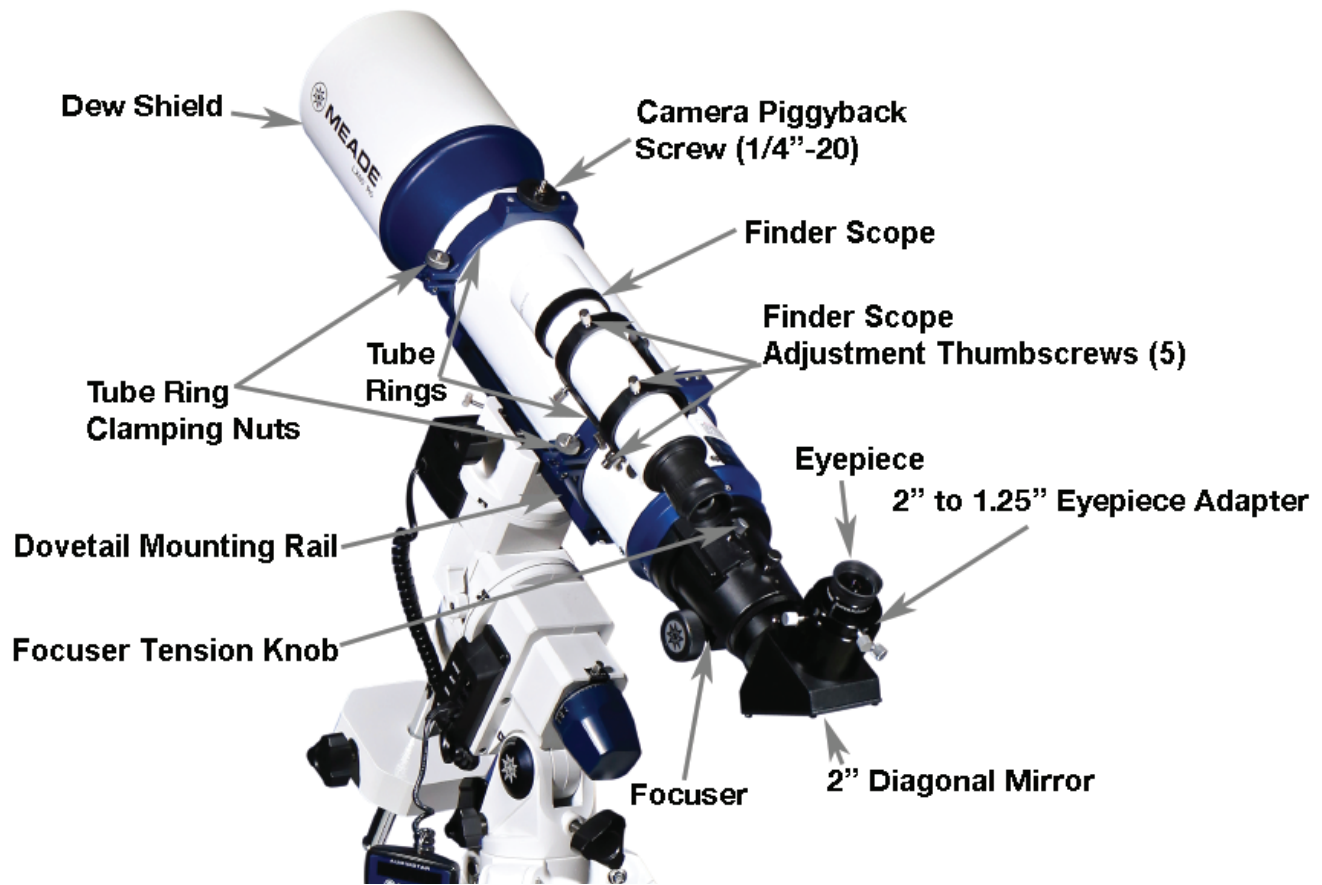

LX85 Parts List

LX85 EQ Head
Counterweight Shaft
Altitude Knobs (Adjustment & Lock)
Azimuth Adjustment Knobs
9 lbs Counterweight
AudioStar Handbox
Cable for AudioStar Handbox
Cable for Declination Motor
Tripod with Center Rod and Accessory Tray Nut
Accessory Tray
Compass
Instruction Manual

#217001 with 5" Refractor Parts List

Optical Tube Assembly with Tube Rings and Dust Caps
8x50 Finder Scope
1.25" Plössl Eyepiece, 9mm
1.25" Plössl Eyepiece, 26mm
2" Diagonal Mirror

#217003 with 6" Reflector Parts List

Optical Tube Assembly with Tube Rings and Dust Caps
8x50 Finder Scope
1.25" Plössl Eyepiece, 9mm
1.25" Plössl Eyepiece, 26mm

#217004 with 8" Reflector Parts List

Optical Tube Assembly with Tube Rings and Dust Caps
8x50 Finder Scope
1.25" Plössl Eyepiece, 9mm
1.25" Plössl Eyepiece, 26mm

#217002 with 6" Maksutov-Cassegrain

Parts List

Optical Tube Assembly with Visual Back and Dust Caps
8x50 Finder Scope
1.25" Plössl Eyepiece, 9mm
1.25" Plössl Eyepiece, 26mm
1.25" Diagonal Mirror

#217005 with 6" ACF Parts List

Optical Tube Assembly and Dust Caps
8x50 Finder Scope
1.25" Plössl Eyepiece, 9mm
1.25" Plössl Eyepiece, 26mm
1.25" Diagonal Mirror
Visual Back

#217006 with 8" ACF Parts List

Optical Tube Assembly and Dust Caps
8x50 Finder Scope
1.25" Plössl Eyepiece, 9mm
1.25" Plössl Eyepiece, 26mm
1.25" Diagonal Mirror
Visual Back

#217010 with 70mm Astrograph Refractor

Parts List

Optical Tube Assembly with Tube Rings and Dust Caps

48mm to 42mm Adapter

Vixen-style Dovetail

Hard Carry Case

#217008 with 80mm APO Refractor

Parts List

Optical Tube Assembly with Tube Rings and Dust Caps

2" to 1.25" Adapter

Vixen-style Dovetail

Hard Carry Case

#217009 with 115mm APO Refractor

Parts List

Optical Tube Assembly with Tube Rings and Dust Caps

2" to 1.25" Adapter

Vixen-style Dovetail

Hard Carry Case

Assembly

Begin unpacking the box contents and start assembling the mount during the day to become familiar with the parts and operation of the LX85.



Assembling the Tripod

1. Setup the telescope in a large open area where you can see lots of sky and where the North Star (Polaris) is visible. Don't setup right next to a building or a wall where your view of the night sky will be obstructed. Make sure the ground is stable and is approximately level. Always setup the telescope in a safe area away from roads and traffic. It is best to set up the scope away from bright nighttime lighting. Bright lights will spoil your night vision and impede your ability to see the sky.

2. Stand the tripod vertically with the tripod feet down and with the tripod still fully collapsed. Grasp two of the tripod legs and, with the full weight of the tripod on the third leg, gently pull the legs apart to a fully open position.

3. Adjust the height of the tripod by loosening the Height Adjustment Lock Knobs at the bottom of each leg, one at a time. Raise the leg to the desired level then tighten the lock knob. The tripod should be reasonably level but it does not need to be precisely level when using an EQ mount.

Attaching the LX85 Mount to the Tripod

1. Locate the Azimuth Alignment Post on the top side of the tripod.

2. Place the LX85 mount on the top of the tripod so that the side which contains the motor covers (the north side of the mount) is positioned over the Azimuth Alignment

Post. While holding the mount onto the top of the tripod with one hand, secure the mount to the tripod by threading in the tripod Center Rod Mount Locking Nut.

3. Attach the two Azimuth Adjustment Knobs to the mount. They should just be finger tight.

4. Attach the Altitude Adjustment Knobs to the back (south) side of the mount.

Setting the Latitude

We suggest roughly setting the latitude on the mount before more weight is added. This makes the larger adjustments easier.

1. Loosen the front (north side) Altitude Lock Knob a



few turns to allow room for adjustment.

2. Move the back (south side) Altitude Adjustment Knob until the degree scale on the mount matches

the latitude for your observing site. For example, in Los Angeles, CA, adjust the mount until the scale is at 34°.

5. Attach the Altitude Lock Knob to the front (north) side of the mount and lightly tighten. This locks the mount's latitude position in place and prevents the mount from moving during future transport.

You can find the latitude of your observing site from your smartphone, quick internet search, or geographical map. You will fine tune this adjustment later while under the night sky.

If the back (south side) Altitude Adjustment Knob stops moving, you will need to loosen the front (north side) Altitude Lock Knob more to allow room for adjustment. Note the front knob just keeps the mount from lifting during transport, so you can keep this completely loose until your polar alignment is complete.

Attaching the Accessory Tray

Reminder: The LX85 head should be firmly attached to the tripod before attaching the accessory tray.

1. Remove the Accessory Tray Nut from the Center Rod and slide the accessory tray up until it comes in contact with the tripod legs. The Accessory Tray arms should align with each leg before tightening the Accessory Tray Nut.
2. Attach the Nut and firmly tighten until the Accessory Tray is in full contact with all three tripod legs.
3. Push against the Accessory Tray and check that it does not move against the tripod. It should be firmly in place. This not only assures that the Accessory Tray is properly installed, it also makes the tripod more rigid to better support the weight of the telescope.

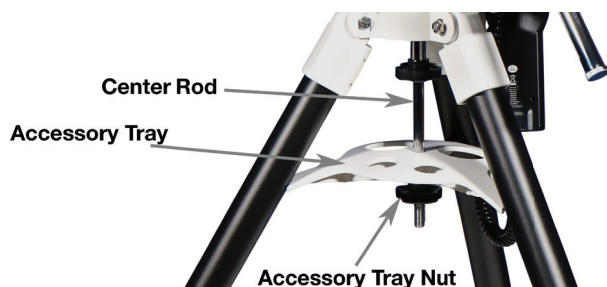

Attaching the Counterweight Shaft and Counterweight(s)

1. The Counterweight Shaft and Counterweight Shaft Locking Nut are packed separately in the box and need to be assembled before the Counterweight is installed. To assemble, thread the Locking Nut onto the top of the Counterweight Shaft until it stops.
2. Now thread the Counterweight Lock Nut up the shaft until it stops. The Lock Nut helps to stabilize the Counterweight shaft during use.
3. Unlock the Right Ascension (R.A.) Lock Lever and position the Counterweight Shaft so that it's pointing downward towards the ground. Remove the Safety Nut and slide the *Counterweight to the middle position of the Counterweight Shaft. You will later adjust the position of the Counterweight to balance the mount after the tube assembly and accessories have been added.
4. Lock the R.A. Lock Lever so that it does not move when installing the Optical Tube.

*Install the second counterweight if your LX85 telescope came with two counterweights. If so, the second counterweight will be packaged separately.

Installing the AudioStar and Cables

1. Plug the Declination Cable into the port on the Control Panel labeled "DEC", then plug the other end of the cable to the port located on the Declination Motor Housing Cover.
2. Plug the AudioStar cable into the port on the Control Panel labeled "HBX", then plug the other end into the bottom of the AudioStar Handbook.
3. Attach the AudioStar Hanger Clip to the back side of the handbook by squeezing the sides of the clip so they fit into the two mounting holes, then hang it from the Accessory Tray or other convenient location.



Installing the Telescope Optical Tube

Any optical tube with a Vixen-style dovetail bar can be attached to the LX85. Before attaching an Optical Tube, make sure the total weight of the optical tube with accessories is below the stated payload capacity of the LX85 Mount. Visit the Meade website (www.Meade.com) for the LX85 payload capacity. Make sure the mount and tripod are already setup in the location you wish to observe before attaching the optical tube.

1. Position the Right Ascension (R.A.) so that the counterweights face downward towards the ground, and Declination (Dec) so that the Dovetail Saddle runs north/south along the mount. This is the home position of the mount and the most secure position to attach the optical tube.
2. Firmly tighten both the R.A. and Dec Lock Levers.

Reminder: The Counterweight(s) should already be installed before attaching the optical tube!

3. Loosen the Dovetail Attachment Screws to make

room for the dovetail bar on the optical tube, but do not remove the screws.

4. Place your optical tube's dovetail bar flat against the Dovetail Saddle of the LX85. Use caution and make sure the bar is flat against the saddle. Position the optical tube so that it's about midway on the LX85 mount.

5. With one hand holding onto the optical tube, use your other hand to tighten the Dovetail Attachment Screws. Check that everything is secure to before letting go of the optical tube.

Hint: For larger and heavier telescopes, we recommend enlisting the help of a second person to assist installing the optical tube onto the mount. Working with an equatorial mount can take some time to get used to, so having someone spot you while installing the optical tube can help greatly.

Installing the Accessories

Refer to the Optical Overview section on pages 8-11 for your particular LX85 optical tube.

1. If not already installed, thread the Visual Back (ACF and Maksutov only) to the back of the telescope.
2. Insert the Diagonal Mirror (ACF, Maksutov, and Refractor only) and secure it with the locking thumbscrew. If an imaging camera will be used, it will be beneficial to not use the diagonal mirror at all.
3. Insert the eyepiece into the focuser (for reflectors) or the Diagonal Mirror and secure it in place with the locking thumbscrew. Always start with the lower power 26mm eyepiece.
4. Insert the 8x50 Finder Scope into the Finder Scope Bracket and secure it to the telescope with the locking thumbscrews.
5. Install any other accessories that will be used including dew shields, filter wheels, guider cameras etc before moving forward to the balancing procedure.

Balancing the LX85

Whether you are using an LX85 series optical tube, or an optical tube of your own, balancing the LX85 equatorial mount allows for safe operation and to achieve the best stability, tracking, and pointing accuracy.

1. Verify all accessories are installed and dust covers removed before balancing the telescope.

Balancing the R.A. Axis

2. Carefully unlock the R.A. Lock Lever while holding onto the telescope. Move R.A. so that the counterweight shaft is horizontal.

3. Gradually let go of the telescope and see which way it starts to swing. If it swings towards the optical tube, slide the counterweights down the counterweight shaft; if towards the counterweight side, slide them upward. Do this until the R.A. axis does not move when the R.A. Lock Lever is unlocked. A well balanced R.A. will reduce motor strain and improve the telescope performance.

Balancing the Dec Axis

4. With the R.A. counterweights shaft still pointing horizontally, tighten the R.A. Lock Lever.

5. Carefully unlock the Dec Lock Lever while holding onto the optical tube.

6. Gradually let go of the optical tube and see which way it starts to swing. If it swings forward (towards the opening of the optical tube), then the Dec axis is front-heavy; if backward it is back-heavy.

7. Move the optical tube back to the home position (in R.A., counterweight shaft pointing downward towards the ground; in Dec, optical tube facing north to safely balance in Dec. This way, the optical tube will be held down by gravity once you unlock the Dovetail Attachment Screws.

8. Carefully unlock the Dovetail Locking Screws while holding onto the optical tube, then slide the scope forward or backward slightly as needed to reach balance. You may have to go back to steps 4-6 to determine when the telescope is balanced in Dec.

Note: In some cases you can adjust the optical tube position within the tube cradle rings to achieve a balanced system. To do this loosen the cradle ring lock knobs slightly and slide the OTA forward or backward in the cradle rings until balanced. Then lock the cradle

ring lock knobs firmly in place.

After using the LX85 for the first couple of times you will soon be able to run through the balancing procedure quickly and easily.

<!>Caution: If the telescope is severely out of balance, it may tend to quickly fall to one side. Always hold on to the telescope whenever you unlock one of the levers to prevent accidental damage.

The Telescope Home Position

The Home Position is the starting position of your telescope before starting an alignment. This is also considered the default position for the mount when setting up.

The R.A. axis should be positioned so that the Counterweight Shaft is pointing downward toward the ground.

The Dec axis should be positioned so that the Optical Tube Assembly is pointing north (or south

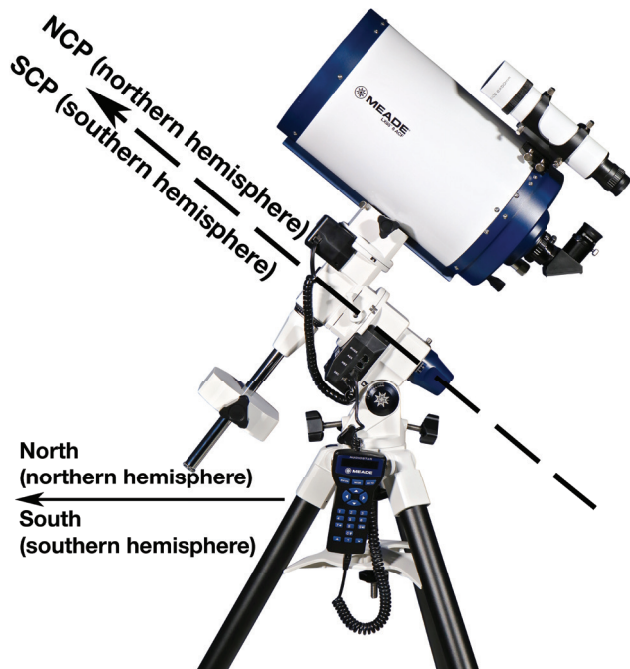

LX85 Home Position

in the Southern Hemisphere). The Optical Tube Assembly points toward the forward-facing tripod leg with the “N” label.

To help indicate the correct Home Position, the LX85 has an index mark on the R.A. and Dec axis. Unlock the R.A. and Dec Lock Levers and position the telescope to align with the index marks, then lock both levers. The mount must remain locked so that you can successfully perform an alignment and accurately locate objects with the AudioStar.

Aligning The Finder Scope

All LX85 telescopes are equipped with an 8x50 optical Finder Scope. This is essentially a small, low powered telescope with centered crosshairs designed to help you locate an object before centering it in the field of view of your telescope. Without the Finder Scope, it would be difficult to initially locate anything because the field of view through your main telescope is much smaller. The Finder Scope is primarily used to help you locate your alignment stars when using the AudioStar handbox. But it proves useful when trying to locate and center new objects.

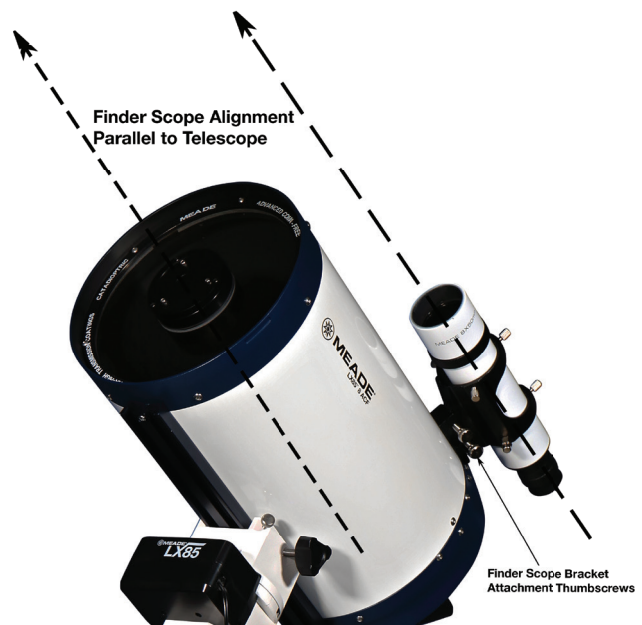

There are 5 adjustment screws and 1 spring-loaded tensioning screw which helps keep the finder seated in its bracket. To align the finder:

1. Using the 26mm eyepiece, locate an object at least 1000 yards away during the day, or a bright star at night.
2. Center the object in your eyepiece.
3. Now, look through the Finder Scope. The object will be away from the center point of the crosshairs. Adjust the 5 adjustment screws until the object is centered in the crosshairs.
4. Check the view both through the main telescope and the Finder Scope.

Once aligned, you typically do not have to realign unless the Finder Scope is moved.

Note: Aligning the Finder Scope during the day can be easier before beginning your observing session. However, for best accuracy, you should eventually align on a bright star in the sky or a very distant object during the day, such as a mountaintop. This is because objects closer than “infinity” focus exhibit parallax.

Reminder: Never look at the Sun with your telescope or finder scope! Use extreme caution whenever operating the telescope during the day.

Polar Alignment

The LX85 is a German Equatorial Mount designed to precisely track any object in the sky. To work properly, the mount must be polar aligned so that the Right Ascension axis follows the apparent motion of the night sky. If the mount is not accurately polar aligned, objects will eventually drift out of the field of view of the telescope.

Please note that the polar alignment is a mechanical alignment, which is independent of the computerized go-to alignment of the AudioStar. Before even turning the mount on, you should at least have the LX85 roughly polar aligned.

An optional Polar Axis Finder Scope #617006 is available from Meade. For northern hemisphere observers, it allows you to sight Polaris (the North Star) to quickly locate the North Celestial Pole (NCP) and achieve a fast polar alignment.

To roughly polar align your LX85:

1. Place the telescope in the home position (counterweight shaft facing downward towards the ground, optical tube facing the north side of the mount, R.A. and Dec aligned to the index marks).
2. Without unlocking the R.A. and Dec Lock Levers, roughly position the LX85 so that it's facing true north (or south in the Southern Hemisphere). You can use the included magnetic compass to get you close but remember the compass will point toward Magnetic North and not True North. It may be necessary to reposition the tripod so the North tripod leg points roughly near True North. You can adjust the Azimuth Adjustment Knobs to fine tune the pointing if necessary. If it's already dark enough to see Polaris, use that as your target for true north.
3. Loosen the front (north side) Altitude Lock Knob a few turns to allow the Altitude Adjustment knob to be adjusted.
4. Move the back (south side) Altitude Adjustment knob until the Latitude Scale on the mount matches the latitude for your location. For example, in Los Angeles, CA, adjust the mount until the scale is at 34°.
5. With the viewfinder already aligned with the optical tube (see the section on Aligning the viewfinder if needed), locate Polaris in the finder scope. If Polaris is not in the finder scope, use the Azimuth and Altitude adjustment knobs to reposition the mount. If you run out of adjustment travel, you will need to reposition the tripods position.
6. Move the azimuth (left/right) by loosening one of the Azimuth adjustment knobs while tightening the other.
7. Move the altitude by turning the Altitude Adjustment knob as needed until Polaris is centered in the finder scope.

This will achieve a rough polar alignment. The same procedure can be done using the optional Meade #617006 Polar Axis Finder for more accurate polar alignment. Additionally, other methods can be used, such as drift align, optional third party accessories, and/or software tools to help precisely polar align the LX85 Mount.

Operating the LX85

Powering the LX85

The LX85 requires 12V DC with at least 5 amperes of current with tip positive polarity. Most portable 12V field batteries can provide this. The optional Meade AC Power Adapter (#07584) can be used if you have access to an AC outlet. The power input port uses a 5.5mm outside diameter and 2.5mm inside diameter socket.

Turn the mount on by flipping the rocker switch to the up position. A red L.E.D. on the rocker switch will light to indicate it's in the ON position.

Moving Through AudioStar's Menus

The AudioStar database is organized in levels for quick and easy navigation.

-
Press ENTER to go deeper into AudioStar's menu levels.
-
Press MODE to move back toward the top menu level. This is similar to a back button.
-
Press GOTO to move to objects in the database. Use this after you perform a night sky alignment and have selected an object from the Audiostar database.
-
Press the central Arrow keys to electronically move the telescope in a specific direction or in combination with the number keys to input characters and digits.
-
Press the bottom Scroll keys to move up and down through the AudioStar menus.

Initializing AudioStar

This section describes how to use AudioStar for the first time, or after performing a reset (see "RESET" on page 33).

1. Verify that AudioStar is properly connected to the LX85 mount. See "Installing the AudioStar and

Cables" on page 15.

2. Turn the telescope power switch to the ON position. The AudioStar beeps and the display screen is activated. Then AudioStar takes a few moments to start up the system.

3. "Press 0 to Align or Mode for Menu" displays. Press 0 to align your telescope using the "Easy Align" method, see "Easy (Two-Star) Align" on page 20. To skip the alignment process, select an alternative alignment, or access the AudioStar menus, press the Mode key instead.

4. The telescope then tests the motor function of the telescope by moving a small amount in the horizontal and vertical directions. This motor test only occurs on the first power up and will not occur again unless the handbox is RESET.

5. Set Your Location or Zip Code: The Location screen displays. This screen asks you if you wish to choose either the zip code of your observing location or the location (i.e., entering the city and state or country of your observing location). Press "1" to select the zip code option or "2" to enter the city and state.

Note: The location settings (country/state/province and city, or zip code) are only asked for the first time you turn on the mount. If you wish to change this setting later on, use the Site menu. See SITE, page 32 for more information.

A. If you chose the zip code option, the left most "0" is highlighted. Use the Number keys to enter the digits. As you enter a digit, the next digit to the right will be highlighted. Enter the next digit. Repeat this process until all 5 digits of your zip code are entered. Press ENTER.

B. If you chose the location option, the next screen asks for the country or state/province (listed alphabetically) of the observing site.

i. Use the Scroll keys to scroll through the list of countries, states, and provinces. Press ENTER when the correct location displays.

ii. The next screen asks for the city (listed alphabetically) closest to the observing site. Use the

Scroll keys to scroll through the list of cities. Press ENTER when the correct city appears on screen.

6. The next screen requests the status of Daylight Savings Time. If Daylight Savings Time is active, press the "1" key. If Daylight Savings Time is not active, press the "2" key.

7. AudioStar then asks for the Telescope Model. Using the scroll keys on the AudioStar locate the model of your telescope and press enter.

Note: If you are using a optical tube not shown in the LX85 telescope model database, select "LX85 Mount" and enter in the optical tubes focal length when prompted.

8. "Enter Date" appears. Use the AudioStar keypad to enter the date.

9. "Enter Time" appears. Use the AudioStar keypad to enter the time.

10. Initializing Smart Drive will then appear. The mount will now move slowly in RA for 30 seconds while it searches for the RA worm index sensor. When the sensor is located "Select Item: Object" appears. If the worm index sensor is not located on the first attempt, power cycle the mount to locate the sensor.

System initialization is now complete and AudioStar enters into the Easy Alignment routine. See "Easy (Two-Star) Alignment" for performing an alignment on the night sky. If you do not wish to begin an alignment on the night sky, press the MODE key to exit to the main AudioStar menu.

Easy Alignment with AudioStar

The LX85 must be aligned so that the AudioStar can accurately point to objects in the night sky. Alternatively, you can choose to simply use the mount's tracking ability to track a star or solar system object (read more in AudioStar Features on pg 22).

1. Unlock the R.A. and Dec Lock Levers and manually move the telescope to the home position (see the Telescope Home Position on pg 17). The counterweight shaft should be pointing downward towards the ground and the optical tube should be pointing north (or south in the Southern Hemisphere).

2. Lock the R.A. and Dec Lock Levers.

From this point forward, you should not move the mount manually or unlock R.A. or Dec, otherwise the AudioStar alignment will be lost.

3. Power on the LX85 by pushing the rocker switch to the up position. A red LED will light on the rocker switch to indicate the mount is in the ON position.

4. "Press 0 to Align" or "Mode for Menu" appears on the AudioStar display. Press 0 to begin the Easy Alignment. If AudioStar has already completed initialization, the Easy Alignment can be started by going to the Setup/Align menu and selecting Easy.

The AudioStar will display scrolling text describing how to put the telescope into the home position. To skip this press Enter. The LX85 will slew to the first of two bright alignment stars. These stars are the brightest stars in that area of the sky and should be stand out from surrounding stars nearby. Your telescope may not be pointing directly at the star, but it should be in the area, usually close enough to sight within the finder scope.

5. While looking through the finder, use the central arrow keys to center the alignment star in the finder. When centering the alignment star select the proper motor slew speed by pressing the 0-9 keys on the AudioStar. See Slew Speeds on page 23 to learn about the different slew speeds. When centering targets it is best to use a slower more precise slew speed.

6. Now, look through the eyepiece and use the Arrow Keys to center the star in the eyepiece's field of view, then press ENTER.

Note: If during the 2 star alignment process the telescope points to an area of sky that is obstructed, you can select a different star by pressing one of the bottom Scroll Keys.

7. Repeat the procedure for the second alignment star.

When the procedure is performed correctly, "Alignment Successful" displays. If AudioStar does not display this message, or displays "Alignment Failed" perform this procedure again and confirm you are centering the correct alignment stars.

Hint: The GO TO key also allows you to perform

a “spiral search”. A spiral search is useful when the telescope slews to an object, but that object is not visible in the eyepiece after the telescope finishes its search. (This sometimes occurs during an alignment procedure.) Press GO TO when the slew is finished and the telescope starts slewing in a spiral pattern at a very slow speed around the search area. Look through the eyepiece and when the object does become visible, press MODE to stop the spiral search. Then use the Arrow keys to center the object.

Once aligned, your LX85 is ready to locate from thousands of objects contained in the AudioStar’s database.

Go To Your First Object

Different celestial objects are visible at different times of the year. And depending on your observing location, possible obstructions (like trees, buildings, etc.) some objects will be more suitable for your particular observing session. Solar system objects including the Moon, Jupiter and Saturn (when visible) are excellent first targets to observe. And, unlike fainter deep sky objects, these Solar System objects are not really affected by light pollution from city locations.

Reminder: Once aligned, only use the GO TO or Arrow keys to move the telescope. Do not move the telescope manually, or alignment will be lost.

1. After the telescope is aligned, “Select Item: Object” displays. Press ENTER.
2. “Object: Solar System” displays. Press ENTER.
3. “Solar System: Mercury” displays. Keep pressing the Scroll Down key until a bright planet which is currently visible displays; for example, Saturn.
4. Press ENTER. “Calculating” displays. Then “Saturn” and a set of coordinates displays. Note that Saturn’s (and other planets’) coordinates change throughout the year.
5. Press GO TO. “Saturn: Slewing...” displays and the telescope slews until it finds Saturn. You may need to use the Arrow keys to center

Saturn precisely in the eyepiece. AudioStar then automatically moves the telescope so that it “tracks” Saturn (or whatever other object you may have chosen); i.e., Saturn remains centered in the eyepiece.

After you Go To Saturn, practice the Go To feature with other objects in the Object menu lists. For example, during Winter, choose M42, the Orion nebula, from the Messier list. Or in the summer, choose the Dumbbell nebula from the Deep Sky, Named Objects list.

Using the Guided Tour

This example demonstrates using “Tonight’s Best” Guided Tour.

1. After observing Saturn, press mode three times so that “Select Item: Object” displays again.
2. Press the Scroll Down key twice. “Select Item: Guided Tour” displays.
3. Press ENTER. “Guided Tour: Tonight’s Best” displays. Press ENTER.
4. “Tonight’s Best: Searching...” displays. After calculating, “Tonight’s Best: Jupiter” displays.

If you wish to try out other Guided Tours, press the Scroll Down key to scroll through other tour choices. When the tour you wish to select displays, press ENTER.

Note: Different objects may be displayed on a tour list on any given night. Press ENTER to display information about the object. Press GO TO to move the telescope to the object.

5. Press MODE to return to the Tour list. Press the Scroll keys to scroll through the list. Press ENTER when you find the next object you wish to observe.
6. Press and hold down MODE for two seconds to leave the Guided Tour menu.

The AudioStar Handbox

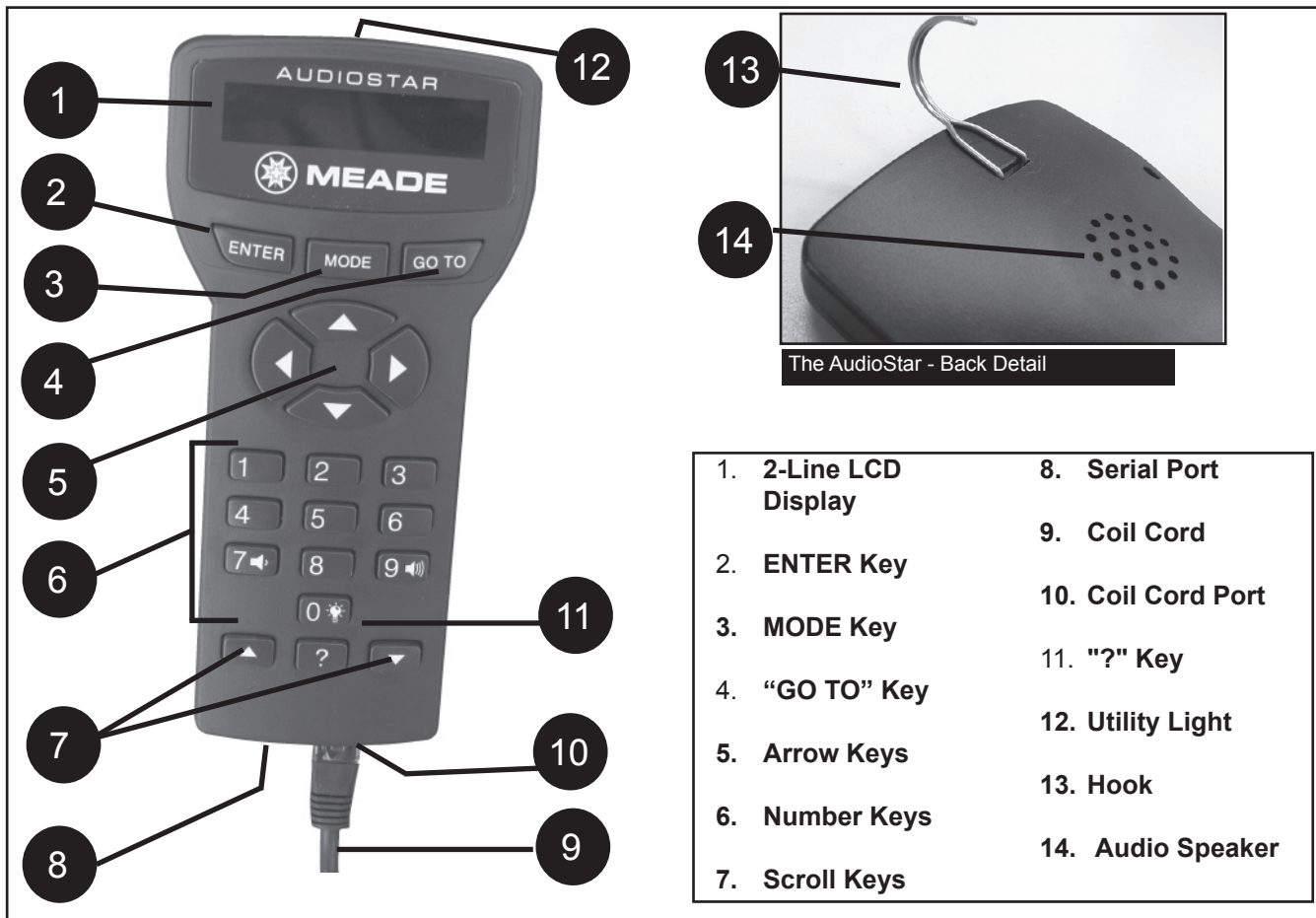

Tour the Cosmos with Just the Push of a Button

Control of the LX85 is through the operation of the standard-equipment AudioStar. Nearly all functions of the telescope are accomplished with just a few pushes of AudioStar's buttons. Some of the major features of AudioStar are:

- Automatically move the telescope to any of over 30,000 objects stored in the database or manually enter the astronomical coordinates of any celestial object.
- Take a guided tour of the best celestial objects to view on any given night of the year.
- Meade's Astronomer Inside audio content. Listen through its built-in speaker as it tells you fun and informative descriptions of over 500 night sky objects as you actually view them in the eyepiece.

- Download the latest software revisions directly from the Meade website (www.meade.com) and share software with other AudioStar enthusiasts.
- Control your LX85 with your PC using an serial interface.
- Access a glossary of astronomical terms.
- Calculate which eyepiece to use for optimum viewing of a celestial object.

The AudioStar Computer Controller provides control of the telescope functions. AudioStar has soft-touch keys designed to have a positive feel. The LCD (Liquid Crystal Display) is back-lit with a red LED (Light Emitting Diode) for easy viewing in the dark. The back-lit display, key arrangement, and sequential database make AudioStar extremely user friendly.

1 2-Line LCD Display: Provides an interface between AudioStar and the telescope.

- **Top line:** Lists the primary category or menu item.
- **Bottom line:** Contains a menu option or information about an object or subject, depending on which function is being performed.

2 ENTER Key: Accesses, in a sequential manner, the next menu or data level in the AudioStar database. See MOVING THROUGH AudioStar's MENUS, page 19.

NOTE: If ENTER is pressed for two seconds or more and then released, AudioStar emits a beep and "ENTER to Sync" is displayed. "ENTER to Sync" is relevant only after the telescope has been aligned and is pointing at an object. If the "ENTER to Sync" feature is accessed by mistake, press MODE to return to the previous screen. See High Precision, for more details about this feature.

3 MODE Key: Returns to the previous menu or data level in the AudioStar database until the top level, "Select Item" is reached. The MODE key is similar to the back key on a smart phone.

Note: Pressing MODE while in the "Select Item" level moves AudioStar to the topmost screen: "Select Item: Object".

If MODE is pressed and held for two seconds or more, information about the telescope's status displays. When the status displays, press one of the Scroll keys to display the following information:

- Right Ascension and Declination (astronomical) coordinates
- Altitude (vertical) and Azimuth (horizontal)

coordinates

- Date
- Site coordinates
- Local Time and Local Sidereal Time (LST)
- Timer and Alarm Status
- Battery status

Press MODE again to return to the previous menu.

4 GO TO Key: Slews (moves) the telescope to the coordinates of the currently selected object. While the telescope is slewing, the operation may be aborted at any time by pressing any key except GO TO. Pressing GO TO again resumes the slew to the object.

5 Arrow Keys: Slew the telescope in a specific direction (up, down, left, and right), at any one of nine different speeds. Speed selection is explained in "SLEW SPEEDS", below. The following functions are also available with the Arrow keys:

- Moves the telescope – Use the Up and Down Arrow keys to move the telescope vertically up and down. The Left Arrow key rotates the telescope horizontally counterclockwise, while the Right Arrow key rotates it clockwise.
- Data entry – When the scope is prompting for user entered data, use the Up and Down Arrow keys to scroll through the letters of the alphabet and numerical digits. The Down Arrow key starts with the letter "A" and the Up Arrow key starts with the digit "9." The Left and Right Arrow keys are used to move the blinking cursor left and right across the LCD display.

0 - 9 and changes the slew speeds (see Slew Speeds, see below). The "0" key also turns on and off the red utility light on the top of the handbox.

Slew Speeds

LX85 has nine slew speeds that are directly proportional to the sidereal rate (the rate at which stars appear to drift across the sky) and have been calculated to accomplish specific functions. Pressing a Number key changes the slew speed, which is shown for about two seconds on AudioStar's display.

To change the speed, press the appropriate key shown below.

Nine available speeds are:

Number Key "1" = 1x (Guide)

Number Key "2" = 2x

Number Key "3" = 8x

Number Key "4" = 16x

Number Key "5" = 64x

Number Key "6" = 0.50°/sec

Number Key "7" = 1.0°/sec

Number Key "8" = 1.5°/sec

Number Key "9" = 4.0°/sec (Max)

Speeds "1", "2", or "3": Best used for fine centering of an object in the field of view of a higher power eyepiece, such as a 12mm or a 9mm eyepiece.

Speeds "4", "5", or "6": Enables centering an object in the field of a low-to-moderate power eyepiece, such as the standard Super Plössl 26mm.

Speeds "7" or "8": Best used for rough centering of an object in the finder scope.

Speed "9": Moves the telescope quickly from one point in the sky to another.

- 7 **Scroll Keys:** Accesses options within a selected menu. The menu is displayed on the first line of the screen. Options within the menu are displayed, one at a time, on the second line. Press the Scroll keys to move through the options. Press and hold a Scroll key to move quickly through the options.

The Scroll keys also scroll through the letters of the alphabet and numerical digits.

Note: The Scroll Down key and the Down Arrow key move forward through the alphabet & digits (A to Z, 0 to 9). The Scroll Up key and the Up Arrow key move backward (Z to A, 9 to 0). Common symbols are also available in the list.

- 8 **Serial Port:** Plug a serial accessory (#505) cable into AudioStar for updating functions such as "Download" or "Clone".

- 9 **Coil Cord:** Plug one end of the AudioStar coil cord into the HBX port of the computer control panel of the telescope and the other end into the coil cord port.

- 10 **Coil Cord Port:** Plug one end of the AudioStar coil cord into this port located at the bottom of the AudioStar handbox.

- 11 **? Key:** Accesses the "Help" file. "Help" provides on-screen information on how to accomplish whatever task is currently active.

Hold down the ? key and then follow the prompts on the display to access details of AudioStar functions in the Help feature. The Help system is essentially an on-screen instruction manual.

If you have a question about an AudioStar operation, e.g., INITIALIZATION, ALIGNMENT, etc., hold down the ? key and follow the directions that scroll on the second line of the LCD screen. When a word appears in [brackets], press ENTER to access the AudioStar Glossary. A definition or more detailed information is displayed. Press MODE to return to the scrolling AudioStar Help display.

When satisfied with the Help provided, press MODE to return to the original screen and continue with the chosen procedure.

- 12 **Utility Light:** Use this built-in red light to illuminate star charts and accessories without disturbing your eye's adaptation to darkness.

- 13 **Hook:** Attach the metal hook to the back side of AudioStar. Allows the AudioStar to be hung on various places on the LX85 for quick access.

- 14 **Audio Speaker:** Built-in speaker plays Astronomer Inside audio content.

Observing Using AudioStar's Arrow Keys

You may observe land and astronomical objects

using AudioStar's Arrow keys to move the telescope.

1. Verify the telescope is fully assembled and that AudioStar is properly connected to your telescope.
2. Flip the telescope power switch to the ON position. The AudioStar screen is activated and a copyright message displays briefly, followed by a short beep. Then AudioStar takes a few moments to start up the system. "Press 0 to align or Mode for Menu" displays (if you select "0", Alignment will begin).
3. The Arrow keys are now activated. Press the Arrow keys to slew (move) the telescope up, down, right, or left.
4. Press a Number key to change the telescope's slew speed. See Slew Speeds, on pg 23 for more information.
5. Use the viewfinder to locate an object and practice using the AudioStar's Arrow keys to center the object in the telescope's field of view.
6. Use the telescope's focus knob to bring the object to focus.

Observe the Moon

Point your telescope at the Moon (note that the Moon is not visible every night) and practice using the Arrow keys and the slew speeds to view different features. The Moon contains many interesting features, including craters, mountain ranges, and fault lines.

The best time to view the Moon is during its crescent or half phase. Sunlight strikes the Moon at an angle during these periods and adds a depth to the view. No shadows are seen during a full Moon, causing the overly bright surface to appear flat and rather uninteresting. Consider the use of a neutral density Moon filter when observing the Moon. Not only does it cut down the Moon's bright glare, but it also enhances contrast, providing a more dramatic image.

Terrestrial Observing

The LX85 is an excellent high-resolution, terrestrial (land) telescope. Viewing terrestrial objects requires

looking along the Earth's surface through heat waves. These heat waves often cause degradation of image quality. Lower power eyepieces, like the Super Plössl 26mm eyepiece, magnify these heat waves less than higher power eyepieces. Therefore, lower power eyepieces provide a steadier, higher quality image.

If the image is fuzzy or ill-defined, reduce to a lower power eyepiece, where the heat waves do not have such an effect on image quality. Observing in early morning hours, before the ground has built up internal heat, produces better viewing conditions than during late afternoon hours.

If you wish to observe a distant land object, such as a mountain top or a bird, you want to use your telescope in its Terrestrial Observing mode. To start up the telescope in Terrestrial mode:

1. Turn on the telescope.
2. Move your telescope using the direction arrows on the handbox while looking through the viewfinder to put your target in the eyepiece.
3. Focus on the target with the focus knob .

AudioStar Operation

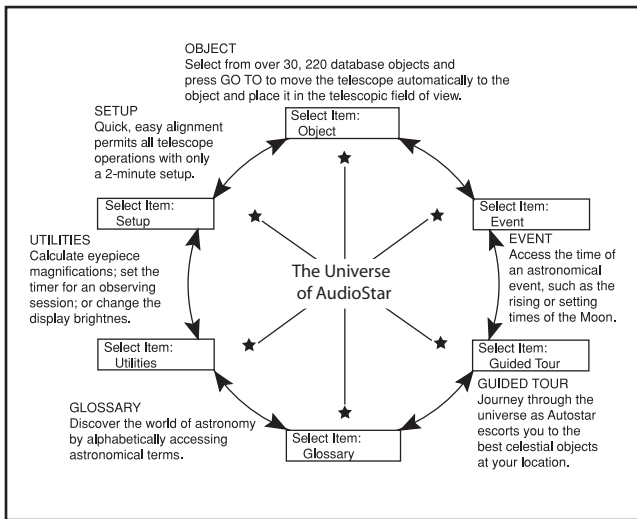

It is important to understand that menu selections are set in a loop. This means that pressing the Scroll Down key cycles down through all the available options within a given category, then returns to the first option. The Scroll Up key cycles up through the options in the opposite order. Note that this capability is a quick way to get to an option that is near the bottom of the list. The following example demonstrates this capability.

Example:

To navigate to the “Select Item: Setup” menu option when the “Select Item: Object” menu is displayed:

1. Press the Scroll Down key four times or the Scroll Up key once.

The screen displays two lines of information. The top line shows the current menu level. The second line displays an option which may be selected within that menu level. Some options are choices that select the next menu level down. The Scroll keys move up and down within the list of available options, showing one option at a time.

When the desired option is displayed on the second line, press the ENTER key to choose that option and move down one menu level.

Press the MODE key to leave a level; e.g., the wrong menu option is chosen.

Important Note: No matter how many levels into AudioStar are traveled, each press of the MODE key moves up a level, until the top level, “Select Item”, is reached. Once in the Select Item level, press MODE to return to the topmost level, “Select Item: Object”.

AudioStar Navigation Exercise

To demonstrate how the AudioStar menu structure works, the following exercise calculates Sunset time so an evening observing session can be planned.

To Calculate Sunset time:

1. Press the MODE key several times, until “Select Item: Object” is displayed.
2. Press the Scroll Down key once to display the “Event” option in the “Select Item” menu.
3. Press the ENTER key to choose the “Event” option and move down a level. “Event: Sunrise” is displayed.
4. Press the Scroll Down key once to display the “Sunset” option in the Event menu.
5. Press the ENTER key to choose the “Sunset” option and move down another level.
6. AudioStar calculates the Sunset time based on the current date, time, and location. AudioStar then displays the results of the calculation.
7. Press MODE once to start moving back up through the AudioStar levels. The first level up

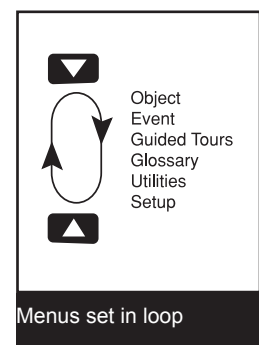
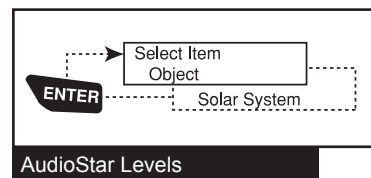

is the Event menu.

8. Press MODE again to move up another level. This is the top level, "Select Item".
9. Press MODE again to return to the starting point of "Select Item: Object".

Entering Data into AudioStar

- To enter numbers and text:
 - A) Use the Number keys, or
 - B) Use the Arrow keys to scroll through numbers 0 - 9 and the alphabet. The Down Arrow key begins with the letter "A"; the Up Arrow key begins with digit "9".
- To move the cursor across the display: Use the Right or Left Arrow key to move the cursor from one number to the next in the display
- Press ENTER when the desired information has been entered.

Navigating AudioStar

AudioStar's menus are organized for quick and easy navigation:

- Press ENTER to go deeper into AudioStar's menu levels.
- Press MODE to move back toward the top menu level.
- Press the Scroll keys to move up and down through the options or lists.
- Press the Arrow keys to move the cursor across the display.
- Press the Help (?) key to access on-line help.

When multiple choices are available within a menu option, the option that is currently selected is usually displayed first and highlighted by a right pointing arrow (>).

Guided Tour Menu

When Guided Tours is selected, LX85 shows you a list of theme tours that will help you explore the night sky. These tours are pre-programmed presentations of

objects that are visible for the user's particular location, time and date.

The most popular tour is "Tonight's Best" that guides the user to the best objects that are currently up in the night sky. This tour is the easiest way to get started exploring the cosmos with your new LX85 telescope.

Each tour will select the objects, present information about the object and, if you press "GoTo", put that object in the eyepiece of the telescope for you to view.

The telescope comes pre-loaded with:

- "Tonight's Best", a selection of the most interesting objects visible on any night.
- "A Star's Life", tours how stars are formed, created, changes through their lives and finally die using examples that are visible tonight.
- "How Far is Far", tour showing the phenomenal distances you can see with your LX85.

AutoStar Suite Software also allows you to create your own guided tours of the skies, including your own objects and titles (for complete instructions on how to use the authoring tools please refer to the reference manual included on the AutoStar Suite DVD).

Object Menu

Almost all observing with the LX85 is performed using the Object menu category. (NOTE: Exceptions include Guided Tour and Landmarks).

Many LX85 menu categories contain databases. The database is a list of objects, such as stars, planets, comets, nebulae and so forth. When one of these objects is selected from a database by pressing "ENTER" and then "GO TO", LX85 moves your telescope (when properly aligned) and points it at the selected object.

The AudioStar Menu Tree

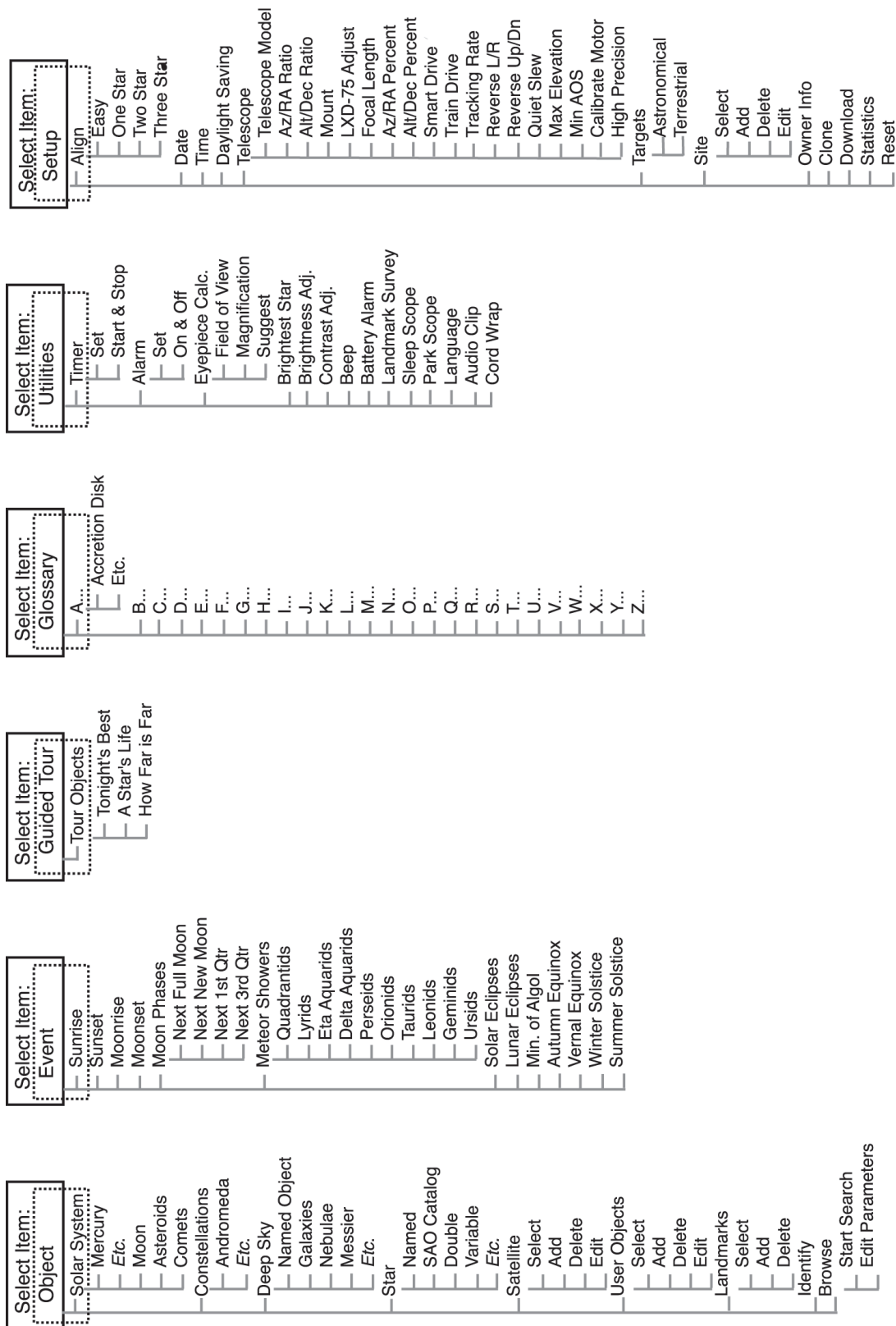

The Object Menu options include:

- **Solar System** is a database of the eight planets (Earth is not included) in ascending orbits from the Sun, followed by the Moon, asteroids, and comets.
- **Constellation** is a database of all 88 Northern and Southern Hemisphere constellations. When this menu option is chosen and a constellation name appears on the first line of the screen, press GO TO once to change the second line to the name of the brightest star in the constellation.

Press GO TO a second time to slew the telescope to that star. Use the Scroll keys to cycle through the list of stars in the constellation, from brightest to dimmest.

- **Deep Sky** is a database of objects outside our Solar System such as nebulae, star clusters, galaxies, and quasars grouped in various catalogs like Messier, Caldwell and NGC.
- **Star** is a database of stars listed in different categories such as named, double, variable, or nearby.

IMPORTANT NOTE: When an object is selected, pressing “ENTER” for two seconds will synchronize the telescope’s coordinates with the object. This is most useful when syncing on bright stars to achieve better pointing in the vicinity of the star.

- **User Objects** allows the user to define and store in memory deep-sky objects of specific interest that are not currently in the LX85 database. **Satellite** is a database of Earth-orbiting objects such as the International Space Station (ISS), the Hubble Space Telescope (HST), Global Positioning System (GPS) satellites, and geosynchronous orbit satellites. In order to find and track satellites, you must download recent orbital data into the telescope.
- **Landmarks** stores the location of terrestrial points of interest that you create in the permanent LX85 database.

IMPORTANT NOTE: To use the Landmark function, the telescope must be located and aligned exactly as when the landmark was added to the database.

- **Select** – To select a Landmark already in the database (see ADD below), choose the “Select” option and scroll through the list. Press “ENTER”

to select a Landmark, then press “GOTO” and the telescope slews to the object.

Add – To add a Landmark, choose the “Add” option. Enter a name for the Landmark. Locate and center the Landmark in the eyepiece, then press “ENTER”.

- **Identify** is an exciting feature for an observer who wants to scan the night sky and start exploring. After the telescope has been properly aligned, use the AudioStar Arrow keys to move about in the sky. Then follow this procedure:

Important Note: Only use the Arrow keys to move the telescope during the Identify procedure. Do not move the telescope manually or the alignment will be lost.

1. When a desired object is visible in the eyepiece, keep pressing MODE until the “Select Item: Object” menu is displayed. Press ENTER to select this menu.
 2. Scroll through the Object menu options until the “Object: Identify” screen appears.
 3. Press ENTER. AudioStar searches the database for the identity of the object being observed.
 4. If the telescope is not directly on an AudioStar database object, the nearest database object is located and displayed on the screen. Press GO TO and the telescope slews to that object.
- **Browse** allows you to search the database for objects with certain parameters, much like a search engine. “Edit Parameters” lets you set various parameters for the search, such as: Object Type, Minimum Elevation, Largest, etc. Once you have set the parameters of the search, select “Start Search” and press ENTER. AudioStar will display the results of the search.

Event Menu

The Event menu provides access to dates and times of astronomical events. The Event database includes:

Sunrise and Sunset calculates the time that the Sun rises or sets on the current date.

Moon rise and Moon set calculates the time that the Moon rises or sets on the current date.

Moon Phases displays the date and time of the next New, 1st Quarter, Full and 3rd Quarter Moon.

Meteor Showers provides information on upcoming meteor showers, such as the Perseids, the Leonids, etc. Also lists the dates of the showers and when they reach maximum.

NOTE: Meteors are fast moving objects that cover large areas of the sky and are usually best observed with the naked eye.

Solar Eclipse lists upcoming Solar Eclipses, including the date and type (total, annular, or partial) of eclipse, and the location and time of the first and last contacts of the Moon's shadow. Use the Scroll Up and Down keys to display the available data. ***Remember, never use a telescope to look at the Sun!***

Lunar Eclipse lists upcoming Lunar Eclipses, including the date and type (total, partial, penumbral) of eclipse. Use the Scroll Up and Down keys to display the available data.

Min. (Minimum) of Algol is the minimum brightness of the dramatic eclipsing binary star system, Algol. It is relatively close at a distance of 100 light years. Every 2.8 days during a 10 hour period, Algol undergoes a major change in apparent magnitude as one of the two stars passes behind the other. The combined magnitude of the two stars thus dips from +2.1 to a minimum of +3.4 halfway through the eclipse as the second star is hidden. LX85 calculates minimum magnitude time at mid-eclipse.

Autumn and Vernal Equinox calculates the time and date of the fall or spring equinox of the current year.

Winter and Summer Solstice calculates the time and date of the winter or summer solstice of the current year.

Glossary Menu

The Glossary menu provides an alphabetical listing of definitions and descriptions for common astronomical terms and AudioStar functions. Access directly through

the Glossary menu or through hypertext words embedded in AudioStar. A hypertext word is any word in [brackets], usually found when using the AudioStar Help function or when reading a scrolling message such as a description of a planet or star. Press ENTER whenever a hypertext word is on screen and AudioStar goes to the glossary entry for that word.

To access directly from the Glossary menu, use the Scroll keys to scroll through the alphabet. Press ENTER on the desired letter. Scroll to the desired entry and then press ENTER to read the description.

Utilities Menu

The Utilities menu provides access to several extra features within AudioStar, including a countdown timer and an alarm. The Utilities functions include:

Timer selects a countdown timer. This feature is useful for functions such as astrophotography and tracking satellites. To use the Timer, press ENTER, then choose "Set" or "Start/Stop."

- **Set:** Enter the time to be counted down, in hours, minutes, and seconds, then press ENTER.
- **Start/Stop:** Activates the timer set previously. Use the Scroll keys to toggle between ON and OFF. When ON is displayed, press ENTER to activate the timer. When the timer runs out, four beeps sound and the timer is deactivated

Alarm: selects a time for an alarm signal as a reminder. To use the Alarm, press ENTER, then choose "Set" or "Start/Stop".

- **Set:** Enter the time of day for the alarm to sound, in hours, minutes, and seconds, then press ENTER.
- **Start/Stop:** Activates the alarm set previously. Use the Scroll keys to toggle between ON and OFF. When ON is displayed, press ENTER to activate the alarm. When the alarm time arrives, AudioStar beeps. Press ENTER to deactivate the alarm.

Eyepiece Calc: calculates information about an eyepiece for the specific telescope to which AudioStar is

connected.

Field of View: Scroll through a list of available eyepieces. When an eyepiece is selected, the field of view is calculated.

- **Magnification:** Scroll through a list of available eyepieces. When an eyepiece is selected, the magnification is calculated.
- **Suggest:** AudioStar calculates and suggests the best eyepiece for viewing, based on the telescope and the object being viewed.
- **Suggest:** Brightness Adj adjusts the brightness of the display using the Scroll keys. When complete, press ENTER.

Contrast Adj adjusts the contrast of the display using the Scroll keys. When complete, press ENTER.

Note: This feature is usually only required in very cold weather.

Landmark Survey automatically slews the telescope to all user-defined landmarks with a short pause at each location. Press ENTER to start the survey. While a slew is in progress, press any key to skip that object and go to the next landmark on the list. To observe a landmark for a longer period, press MODE when paused on the object to stop the survey. Press ENTER to restart the survey at the first object on the list. See Landmarks, page 29.

Sleep Scope is a power saving option that shuts down AudioStar and the telescope without forgetting its alignment. With “Sleep Scope” selected, press ENTER to activate the Sleep function. AudioStar goes dark, but the internal clock keeps running. Press any key, except ENTER, to re-activate AudioStar and the telescope.

Park Scope is designed for a telescope that is not moved between observing sessions. Align the telescope one time, then use this function to park the telescope. Next time it is powered up, enter the correct date and time – no alignment is required. Pressing ENTER causes the telescope to move to its pre-determined Park position. Once parked, the screen prompts to turn off power.

Important Note: When the “Park Scope” option is chosen and the display prompts you to turn off the telescope’s power, AudioStar is unable to be returned to operation without turning the power off and then back on.

Cord Wrap, when set to “On”, moves the telescope in such a way as to prevent the cords and cables attached to your telescope assembly from getting wound around the assembly and tangled as the telescope slews to objects. “Off” is the default setting.

Setup Menu

The Setup menu’s primary function is to align the telescope. However, there are numerous other features available within the Setup menu, including:

Date changes the date used by AudioStar. This function is useful to check events in the past or future. For example, set the Date menu for a day three months in the future. Then check the “Select Item: Event” menu for the Sunset time on that date. See EVENT MENU, page 29.

Time changes the time entered into AudioStar. Setting the correct time is critical for AudioStar to properly calculate locations and events. Time may be set to 24-hour mode (military time) by selecting the “blank” option which follows the “AM” and “PM” options.

Daylight Saving is used to enable or disable Daylight Savings time.

Note: Daylight Savings Time may be referred to by different names in various areas of the world. Check local time to verify.

Telescope accesses the several options, including:

- **Model:** Allows you to select the telescope model connected to AudioStar.
- **Focal Length:** Displays the focal length of the selected telescope.
- **Az Ratio and Alt Ratio:** The Az (Azimuth) ratio and Alt (Altitude) ratio refers to the gears of the telescope’s motors. Do not alter these numbers.
- **Az Percent:** The Az (Azimuth) Percent allows you to change the azimuth backlash, i.e., the way the Arrow keys move the telescope along the azimuth (horizontal) axis. If you enter a value near 100, the telescope tube responds more quickly (it responds immediately at 100%) as you hold down an Arrow key and also slews (moves) the tube more quickly. If you enter

a value near 0, it takes longer for the tube to respond as you hold down an Arrow key and also slews the tube more slowly. Experiment with this option. Try changing the percent value until you get a “feel” for the Arrow keys that is comfortable for you.

- **Alt Percent:** The Alt (Altitude) Percent operates identical to the Az Percent option (see above), but allows you to change the altitude backlash, i.e., the way the Arrow keys move the telescope when moving along the altitude (vertical) axis.

- **Train Drive:** Trains the Altitude and Azimuth motors to locate objects with more precision.

If you are experiencing any problems with pointing accuracy, follow the procedure described in APPENDIX C: TRAINING THE DRIVE, page 49. to insure accurate pointing and tracking.

- **Tracking Rate:** Changes the speed at which the telescope tracks targets in the sky.

A. Sidereal: The default setting for AudioStar; sidereal rate is the standard rate at which stars move from East to West across the sky due to the rotation of the Earth.

B. Lunar: Choose this option to properly track the Moon over long observing sessions.

C. Custom: Allows entry of user-defined tracking rates.

- **Reverse L/R** reverses the functions of the Left and Right Arrow keys (i.e., the Right key moves the telescope to the left).

- **Reverse UP/DOWN** reverses the functions of the Up and Down Arrow keys (i.e., the Up key moves the telescope down).

- **Quiet Slew** sets the maximum slew rate to 1.5° for quieter operation.

- **Max Elevation** allows you to enter a value in degrees that sets a limit as to how far the optical tube can swing upward during a programmed slew. (Note that it does not prevent you from performing a manual slew past this limit.) This is useful when you have a camera or other peripheral attached to the telescope—you can prevent it from striking the telescope base.

- **Min AOS** (Acquisition of Signal) allows you enter a value in degrees. This value represents the altitude at which your telescope begins to slew when acquiring a satellite track. This is useful when you are observing satellites, but a tall tree or building is obstructing the telescope. For example, you might begin to track the satellite at 15° altitude, instead of 5°.

- **Calibrate Motor** if the telescope motors appear to have a problem, use this option to retest the motors before performing a Reset. This option is also used if an AudioStar unit is moved between telescopes, to match AudioStar to the new telescope. To calibrate the motors, select this option and press ENTER.

- **High Precision** if turned on, when looking for a faint celestial object (i.e., a nebula or galaxy), AudioStar first slews to a nearby bright star and displays “Center (Star name) Press Enter”. Center the star in the eyepiece, then press ENTER. At that point the telescope has a high precision alignment to that part of the sky and it then slews to the object that was originally requested.

Targets switches between Astronomical targets and Terrestrial targets. If “**Astronomical**” is selected, the telescope tracking motor is activated and any object you observe will remain centered in the eyepiece. If “**Terrestrial**” is selected, the tracking motor is turned off.

Site provides access to several options including:

- **Select:** Displays the currently selected observing site. Use the Scroll keys to cycle through all available sites (see Add below). Press ENTER when the site you wish to select displays. Use this option when you move to a different geographic location.

- **Add:** Allows you to add new observing sites to the database (up to six sites may be stored). Scroll through the list of Countries/States. Press ENTER when the site you wish to add displays. Then choose the desired city in the same manner.

- **Delete:** Deletes a stored site from the database.
- **Edit:** Edits a selected site, including: the name, latitude, longitude, and time zone. Time Zone refers to the Greenwich Mean Time (GMT) time zone shift. Users West of Greenwich, England use “-” hours, East of Greenwich use “+” hours. For the United States, look up the time zone shift in the table at left.

AudioStar compensates for daylight savings time, if selected.

Owner Info accesses the owner information menu, including:

- **Name:** Users may enter both their first and last names using the Up and Down Arrow keys to cycle through the alphabet. Use the Right and Left Arrow keys to move through the text. Press ENTER when the entry is complete.
- **Address:** Use the Up and Down Arrow keys to enter your street address, city, state, and zip code. Press ENTER when the entry is complete.

Download transfers information from another AudioStar during cloning (see below). During the operation, the warning “Downloading Do Not Turn Off” appears.

Note: The Download function requires the optional #505 Astrofinder Software and Cable Connector Kit. See the instruction sheet included with the kit for more information on how to download.

Clone uploads information from one AudioStar handbox to another. Three options are available:

- **Catalogs:** Sends only user-defined object information, such as new satellite orbits or comet data to another AudioStar handbox.
- **Software:** Sends only the basic AudioStar software. This is useful if one user has downloaded a new version of AudioStar software from the Meade website (www.meade.com) and wants to pass this software along to friends.
- **All:** Everything – user-defined information and AudioStar software – is sent to another AudioStar.

Statistics provides basic statistical data about AudioStar, including:

- **Characters Free:** Shows how much room is available in user-defined object memory.
- **Version:** Shows the current version of the AudioStar software.
- **Reset** completely resets AudioStar. Most values entered into the menus revert to factory defaults.

Periodic Error Correction (PEC) Training

If you wish to perform high-precision astrophotography, you may wish to “train” your telescope in order to keep objects that you are imaging dead center in the telescope’s field of view during the photographic exposure. Periodic error correction (PEC) helps to remove the slight tracking errors that are inherent in the R.A. drive system. To perform this procedure, you need to use a high-power reticle eyepiece, or an autoguider camera properly configured and connected to the Autoguider port.

PEC Train Menu Option

To perform the procedure on the RA axis, pick a bright star in the South near the celestial equator and greater than 30 degrees about the horizon. Using your imaging camera begin auto guiding on the target star and wait about one minute for your guiding corrections to stabilize.

Important Note: The Train option overwrites any previous PEC data recorded.

1. Select “PEC Train” from the Smart Drive menu (in the “Setup: Telescope” menu) and press ENTER.
2. AudioStar will then begin recording the periodic error in the RA worm. A full cycle takes about 10 minutes. When complete AudioStar will return to the PEC menu.

It is advised that you perform one training and then immediately follow-up with two updates for maximum Periodic Error Correction. This level of training is necessary for critical applications such as long exposure photography. Periodic Error Correction

is retained within the AudioStar memory until you overwrite it by performing additional training cycles.

PEC Update Menu Option

PEC Update does not overwrite the data, but updates the training using information gathered from both the last and the current training sessions. If you wish to further refine your training, select this menu again and repeat the procedure. If you do not wish to update the PEC, press the MODE key to exit from this option.

PEC Erase Menu Option

Select this option to erase all PEC training data.

PEC On and Off Menu Options

Select "On" when you want the telescope to use the training information. Select "Off" when you do not want for the telescope to use the training information.

APPENDIX A:

SPECIFICATIONS

Mount	LX85 German Equatorial Mount & Tripod #217000
Mount Type	German Equatorial
Drives	2.91 inch Precision Worm Drive
Power	12 Volts DC, 5 Amperes
Tripod	New Adjustable-Height Steel Leg Tripod
Electronics	
Computer Control	AudioStar Handbox
Guide Port	ST-4 Compatible AutoGuider Port
PC Connection	RS-232 to AudioStar
Included Accessories	
Compass	
9 lbs Counterweight	
AutoStar Suite DVD	
Weight	
LX85 Mount & Tripod	34.1 lbs

SPECIFICATIONS

Model and Product Number	LX85 with 70mm Astrograph #217010
Optical System	
Optical Design	4-Element Petzval Refractor
Aperture (Diameter of Objective)	70mm
Focal Length	350mm
Focal Ratio	f/5
Optical Coatings	Fully Multi-Coated
Optical Glass	FPL 53 ED (Extremely Low Dispersion) Glass
Resolving Power (arc seconds)	1.65
Limiting Visual Stellar Magnitude	11.2
Finder Scope	Optional
Mount	
Mount Type	German Equatorial
Drives	2.91 inch Precision Worm Drive
Power	12 Volts DC, 5 Amperes
Tripod	New Adjustable-Height Steel Leg Tripod
Electronics	
Computer Control	AudioStar Handbox
Guide Port	ST-4 Compatible AutoGuider Port
PC Connection	RS-232 to AudioStar
Included Accessories	
Eyepieces	Not included, for photographic use only
Camera Adapter	48 to 42mm Adapter
Tube Rings and Dovetail Mounting Plate	
Finder Scope	Not included
Weight	
LX85 Mount & Tripod	34.1 lbs
Optical Tube	4.5 lbs
Total Weight	38.6 lbs

SPECIFICATIONS

Model and Product Number	LX85 with 80mm APO Refractor #217008
Optical System	
Optical Design	3-Element Apochromat Refractor
Aperture (Diameter of Objective)	80mm
Focal Length	400mm
Focal Ratio	f/5
Optical Coatings	Fully Multi-Coated
Optical Glass	FPL 53 ED (Extremely Low Dispersion) Glass
Resolving Power (arc seconds)	1.45
Limiting Visual Stellar Magnitude	11.5
Finder Scope	Optional
Mount	
Mount Type	German Equatorial
Drives	2.91 inch Precision Worm Drive
Power	12 Volts DC, 5 Amperes
Tripod	New Adjustable-Height Steel Leg Tripod
Electronics	
Computer Control	AudioStar Handbox
Guide Port	ST-4 Compatible AutoGuider Port
PC Connection	RS-232 to AudioStar
Included Accessories	
Eyepieces	Not included
Eyepiece Adapter	2" to 1.25"
Tube Rings and Dovetail Mounting Plate	
Finder Scope	Not included
Weight	
LX85 Mount & Tripod	34.1 lbs
Optical Tube	6.9 lbs
Total Weight	41 lbs

SPECIFICATIONS

Model and Product Number	LX85 with 115mm APO Refractor #217009
Optical System	
Optical Design	3-Element Apochromat Refractor
Aperture (Diameter of Objective)	115mm
Focal Length	805mm
Focal Ratio	f/7
Optical Coatings	Fully Multi-Coated
Optical Glass	FPL 53 ED (Extremely Low Dispersion) Glass
Resolving Power (arc seconds)	1.0
Limiting Visual Stellar Magnitude	12.3
Finder Scope	Optional
Mount	
Mount Type	German Equatorial
Drives	2.91 inch Precision Worm Drive
Power	12 Volts DC, 5 Amperes
Tripod	New Adjustable-Height Steel Leg Tripod
Electronics	
Computer Control	AudioStar Handbox
Guide Port	ST-4 Compatible AutoGuider Port
PC Connection	RS-232 to AudioStar
Included Accessories	
Eyepieces	Not included
Eyepiece Adapter	2" to 1.25"
Tube Rings and Dovetail Mounting Plate	
Finder Scope	Not included
Weight	
LX85 Mount & Tripod	34.1 lbs
Optical Tube	12.9 lbs
Total Weight	47 lbs

SPECIFICATIONS

Model and Product Number	LX85 with 5" Refractor #217001
Optical System	
Optical Design	2-Element Achromat Refractor
Aperture (Diameter of Objective)	4.72" (120mm)
Focal Length	700mm
Focal Ratio	f/5.8
Optical Coatings	Multi-coated
Resolving Power (arc seconds)	0.9
Limiting Visual Stellar Magnitude	12.39
Finder Scope	8x50 Optical
Mount	
Mount Type	German Equatorial
Drives	2.91 inch Precision Worm Drive
Power	12 Volts DC, 5 Amperes
Tripod	New Adjustable-Height Steel Leg Tripod
Electronics	
Computer Control	AudioStar Handbox
Guide Port	ST-4 Compatible AutoGuider Port
PC Connection	RS-232 to AudioStar
Included Accessories	
Eyepieces	26mm and 9mm Plössl
Tube Rings	Interior Felt-lined
Finder Scope	8x50 Optical
Diagonal Mirror	2" with 1.25" Adapter
Weight	
LX85 Mount & Tripod	34.1 lbs
Optical Tube	12 lbs
Total Weight	46.1 lbs

SPECIFICATIONS

Model and Product Number	LX85 with 6" Reflector #217003
Optical System	
Optical Design	Newtonian Reflector with Parabolic Mirror
Aperture (Diameter of Objective)	5.9" (150mm)
Focal Length	750mm
Focal Ratio	f/5
Optical Coatings	Aluminum with SiO ₂ Overcoat
Resolving Power (arc seconds)	0.76
Limiting Visual Stellar Magnitude	12.9
Finder Scope	8x50 Optical
Mount	
Mount Type	German Equatorial
Drives	2.91 inch Precision Worm Drive
Power	12 Volts DC, 5 Amperes
Tripod	New Adjustable-Height Steel Leg Tripod
Electronics	
Computer Control	AudioStar Handbox
Guide Port	ST-4 Compatible AutoGuider Port
PC Connection	RS-232 to AudioStar
Included Accessories	
Eyepieces	26mm and 9mm Plössl
Tube Rings	Interior Felt-lined
Finder Scope	8x50 Optical
Weight	
LX85 Mount & Tripod	34.1 lbs
Optical Tube	11.4 lbs
Total Weight	45.5 lbs

SPECIFICATIONS

Model and Product Number	LX85 with 8" Reflector #217004
Optical System	
Optical Design	Newtonian Reflector with Parabolic Mirror
Aperture (Diameter of Objective)	7.9" (200mm)
Focal Length	750mm
Focal Ratio	f/5
Optical Coatings	Aluminum with SiO ₂ Overcoat
Resolving Power (arc seconds)	0.76
Limiting Visual Stellar Magnitude	12.9
Finder Scope	8x50 Optical
Mount	
Mount Type	German Equatorial
Drives	2.91 inch Precision Worm Drive
Power	12 Volts DC, 5 Amperes
Tripod	New Adjustable-Height Steel Leg Tripod
Electronics	
Computer Control	AudioStar Handbox
Guide Port	ST-4 Compatible AutoGuider Port
PC Connection	RS-232 to AudioStar
Included Accessories	
Eyepieces	26mm and 9mm Plössl
Tube Rings	Interior Felt-lined
2" to 1.25" Adapter	Included in Focuser
Finder Scope	8x50 Optical
Weight	
LX85 Mount & Tripod	34.1 lbs
Optical Tube	18.4 lbs
Total Weight	52.5 lbs

SPECIFICATIONS

Model and Product Number	LX85 with 6" Maksutov-Cassegrain #217002
Optical System	
Optical Design	Maksutov-Cassegrain
Aperture (Diameter of Objective)	5.9" (150mm)
Focal Length	1800mm
Focal Ratio	f/12
Optical Coatings	Ultra-High Transmission Coatings (UHTC™)
Resolving Power (arc seconds)	0.77
Limiting Visual Stellar Magnitude	12.9
Finder Scope	8x50 Optical
Mount	
Mount Type	German Equatorial
Drives	2.91 inch Precision Worm Drive
Power	12 Volts DC, 5 Amperes
Tripod	New Adjustable-Height Steel Leg Tripod
Electronics	
Computer Control	AudioStar Handbox
Guide Port	ST-4 Compatible AutoGuider Port
PC Connection	RS-232 to AudioStar
Included Accessories	
Eyepieces	26mm and 9mm Plössl
Diagonal Mirror	1.25"
Visual Back	1.25"
Finder Scope	8x50 Optical
Weight	
LX85 Mount & Tripod	34.1 lbs
Optical Tube and Accessories	16.7 lbs
Total Weight	50.8 lbs

SPECIFICATIONS

Model and Product Number	LX85 with 6" ACF #217005
Optical System	
Optical Design	Advanced Coma-Free
Aperture (Diameter of Objective)	6" (152mm)
Focal Length	1520mm
Focal Ratio	f/10
Optical Coatings	Ultra-High Transmission Coatings (UHTC™)
Resolving Power (arc seconds)	0.76
Limiting Visual Stellar Magnitude	12.9
Finder Scope	8x50 Optical
Mount	
Mount Type	German Equatorial
Drives	2.91 inch Precision Worm Drive
Power	12 Volts DC, 5 Amperes
Tripod	New Adjustable-Height Steel Leg Tripod
Electronics	
Computer Control	AudioStar Handbox
Guide Port	ST-4 Compatible AutoGuider Port
PC Connection	RS-232 to AudioStar
Included Accessories	
Eyepieces	26mm and 9mm Plössl
Diagonal Mirror	1.25"
Visual Back	1.25"
Finder Scope	8x50 Optical
Weight	
LX85 Mount & Tripod	34.1 lbs
Optical Tube and Accessories	11.4 lbs
Total Weight	45.5 lbs

SPECIFICATIONS

Model and Product Number	LX85 with 8" ACF #217006
Optical System	
Optical Design	Advanced Coma-Free
Aperture (Diameter of Objective)	8" (203mm)
Focal Length	2032mm
Focal Ratio	f/10
Optical Coatings	Ultra-High Transmission Coatings (UHTC™)
Resolving Power (arc seconds)	0.57
Limiting Visual Stellar Magnitude	13.5
Finder Scope	8x50 Optical
Mount	
Mount Type	German Equatorial
Drives	2.91 inch Precision Worm Drive
Power	12 Volts DC, 5 Amperes
Tripod	New Adjustable-Height Steel Leg Tripod
Electronics	
Computer Control	AudioStar Handbox
Guide Port	ST-4 Compatible AutoGuider Port
PC Connection	RS-232 to AudioStar
Included Accessories	
Eyepieces	26mm and 9mm Plössl
Diagonal Mirror	1.25"
Visual Back	1.25"
Finder Scope	8x50 Optical
Weight	
LX85 Mount & Tripod	34.1 lbs
Optical Tube and Accessories	13.2 lbs
Total Weight	47.3 lbs

APPENDIX B:

Advanced Polar Alignment

You can achieve a satisfactory polar alignment from the method outlined on page 18. However, for astrophotography, a more precise polar alignment may be required, depending on how long your exposure times are. Solar system photography of the Moon and planets do not require perfect polar alignment. But deep sky photography typically involves longer exposures and therefore requires a more accurately polar aligned mount. The better the polar alignment is, the less the mount will drift in the north/south direction (in Declination) which will allow for longer exposure astrophotos..

Celestial Coordinates

A celestial coordinate system was created that maps an imaginary sphere surrounding the Earth upon which all stars appear to be placed. This mapping system is similar to the system of latitude and longitude on Earth surface maps.

In mapping the surface of the Earth, lines of longitude are drawn between the North and South Poles and lines of latitude are drawn in an East-West direction, parallel to the Earth's equator. Similarly, imaginary lines have been drawn to form a latitude and longitude grid for the celestial sphere. These lines are known as Right Ascension and Declination.

The celestial map also contains two poles and an equator just like a map of the Earth. The poles of this coordinate system are defined as those two points where the Earth's North and South poles (i.e., the Earth's axis), if extended to infinity, would cross the celestial sphere. Thus, the North Celestial Pole is that point in the sky where an extension of the North Pole intersects the celestial sphere. The North Star, Polaris, is located very near the North Celestial Pole). The celestial equator is a projection of the Earth's equator onto the celestial sphere.

So just as an object's position on the Earth's surface can be located by its latitude and longitude, celestial

objects may also be located using Right Ascension and Declination. For example: You could locate Los Angeles, California, by its latitude (+34°) and longitude (118°). Similarly, you could locate the Ring Nebula (M57) by its Right Ascension (18hr) and its Declination (+33°).

- **Right Ascension (R.A.):** This celestial version of longitude is measured in units of hours (hr), minutes (min) and seconds (sec) on a 24-hour "clock" (similar to how Earth's time zones are determined by longitude lines). The "zero" line was arbitrarily chosen to pass through the constellation Pegasus, a sort of cosmic Greenwich meridian. R.A. coordinates range from 0hr 0min 0sec to 23hr 59min 59sec. There are 24 primary lines of R.A., located at 15-degree intervals along the celestial equator. Objects located further and further East of the zero R.A. grid line (0hr 0min 0sec) carry higher R.A. coordinates.

- **Declination (Dec.):** This celestial version of latitude is measured in degrees, arc-minutes and arc-seconds (e.g., 15° 27' 33"). Dec. locations North of the celestial equator are indicated with a plus (+) sign (e.g., the Dec. of the North celestial pole is +90°). Dec. locations South of the celestial equator are indicated with a minus (-) sign (e.g., the Dec. of the South celestial pole is -90°). Any point on the celestial equator (such as the constellations of Orion, Virgo and Aquarius) is said to have a Declination of zero, shown as 0° 0' 0."

Alternative Polar Alignments with AudioStar

The AudioStar handbox comes equipped with several different methods to polar align your telescope. These are described briefly below. Easy Polar Alignment

Two alignment stars are chosen by AudioStar based on the date, time and location. The telescope will slew to each AudioStar selected alignment star and you center each star in the eyepiece.

One-Star Polar Alignment

Polar One-Star Alignment requires some knowledge of the night sky. Starting in the telescope's home position, AudioStar will slew to the North Star (Polaris) and have you center it in the telescope eyepiece using only the mechanical latitude and azimuth knobs. Once centered, press enter and AudioStar will select an

alignment star based on your observing sites date, time and location. Center that star in the eyepiece and press enter to complete the alignment.

Two-Star Polar Alignment

Polar Two-Star Alignment requires some knowledge of the night sky. AudioStar provides a database of bright stars and two stars from this database are chosen by the observer for alignment.

Locating the Celestial Pole

To get basic bearings at an observing location, take note of where the Sun rises (East) and sets (West) each day. After the site is dark, face North by pointing your left shoulder toward where the Sun sets. To precisely point at the pole, find the North Star (Polaris) by using the Big Dipper as a guide.

Note: For almost all astronomical observing requirements, approximate settings of the telescope's latitude and Polar axis are acceptable. Do not allow undue attention to precise Polar Alignment of the telescope to interfere with your basic enjoyment of the instrument.

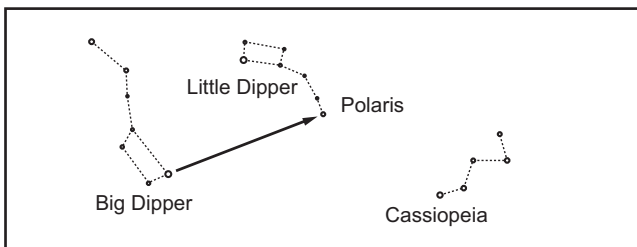

Setting Circles

If you choose not to use AudioStar's automatic go-to pointing from the computerized handbox, the LX85 models are equipped with R.A. and Dec. setting circles to aid in locating faint celestial objects manually when the telescope has been polar aligned. Setting circles emulate the celestial coordinates found on star charts or in sky catalogs. Any charted object is easily located by coordinates in R.A. (in hours, minutes and seconds, from 0h 0m 0s to 23h 59m 59s) and Dec. (in degrees from 0° to ±90°).

When polar aligned, use the Arrow keys to move the telescope in R.A. (left and right keys) and Dec. (up and

down keys).

- **Declination Setting Circle:** The Dec. setting circle has been factory set to read the correct Declination of celestial objects.

- **Right Ascension Setting Circle:** Since celestial objects move in R.A., the R.A. setting circle must be reset as each object is located during an observing session. The R.A. pointer is located on the drive base.

To use the setting circles to find astronomical objects, the LX85 must first be polar aligned. It is advisable that a low-power eyepiece (e.g., a 26mm eyepiece) be employed. Then use the following procedure:

1. Identify the celestial coordinates (R.A. and Dec.) of a bright, easy-to-find object, such as a bright star. (Avoid using Polaris or any object near Polaris.) Coordinates of bright stars are listed in astronomy magazines, text books or star charts. Center this object in the telescope's field of view.

2. Manually turn the R.A. circle to read the R.A. of the object at the R.A. pointer (the molded triangle beneath this setting circle).

3. The R.A. circle is now calibrated to read the correct R.A. of any object at which the telescope is pointed. The Dec. circle is already calibrated through polar alignment.

4. To find another object, again identify the R.A. and Dec. coordinates. Then, without touching the setting circles, move the telescope (manually, by unlocking the vertical and horizontal locks or by slewing the telescope using the Arrow keys) so that the R.A. and Dec. pointers read the coordinates of the second object.

5. If the above procedure has been followed carefully, the second object will now be in the telescope's field of view.

Note: Since the second object (i.e., the object to be located) is in constant motion, once the R.A. circle is calibrated (step 2, above) the telescope should be moved rapidly to read the coordinates of the second object. Otherwise the second object will no longer be in the position indicated by the R.A. circle.

Using setting circles requires a developed technique. When using the circles for the first time, try hopping from one bright star (the calibration star) to another bright star of known coordinates. Practice moving the telescope from one easy-to-find object to another. In this way the precision required for accurate object location becomes familiar.

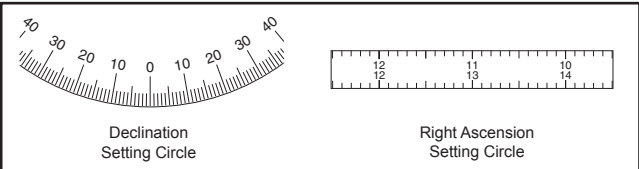

APPENDIX C:

General Maintenance

LX85-Series telescopes are precision optical instruments designed to yield a lifetime of rewarding applications. Given the care and respect due any precision instrument, your LX85 will rarely, if ever, require factory servicing. Maintenance guidelines include:

- a. Avoid cleaning the telescope's optics: A little dust on the front surface of the telescope's correcting lens causes virtually no degradation of image quality and should not be considered reason to clean the lens.
- b. When absolutely necessary, dust on the front lens should be removed with gentle strokes of a camel hair brush or blown off with an ear syringe (available at any pharmacy). DO NOT use a commercial photographic lens cleaner.
- c. Organic materials (e.g., fingerprints) on the front lens may be removed with a solution of 3 parts distilled water to 1 part isopropyl alcohol. You may also add 1 drop of biodegradable dishwashing soap per pint of solution. Use soft, white facial tissues and make short, gentle strokes. Change tissues often.

Caution: Do not use scented or lotioned tissues or damage could result to the optics.

- d. Do not, for any reason, remove the correcting plate from its machined housing for cleaning or other purposes. You will almost certainly not be able to replace the corrector in its proper rotational orientation and serious degradation of optical performance will result. Meade Instruments assumes no liability for damage incurred to the telescope in this way.
- e. If the LX85 is used outdoors on a humid night, water condensation on the telescope surfaces will probably result. While such condensation does not normally cause any damage to the telescope, it is recommended that the entire telescope be wiped down with a dry cloth before the telescope is packed away. Do not, however, wipe any of the optical surfaces. Rather, simply allow the

telescope to sit for some time in the warm indoor air, so that the wet optical surfaces can dry unattended.

- f. Do not leave your LX85 inside a sealed car on a warm summer day; excessive ambient temperatures can damage the telescope's internal lubrication and electronic circuitry.

APPENDIX D:

Training The Drive

Perform this procedure if you are experiencing any pointing accuracy problems. The diagram to the right depicts the complete Drive Training procedure.

NOTE: Use a far away terrestrial object, such as a telephone pole or lamp post, to train the drive.

Complete this exercise once every 3 to 6 months.

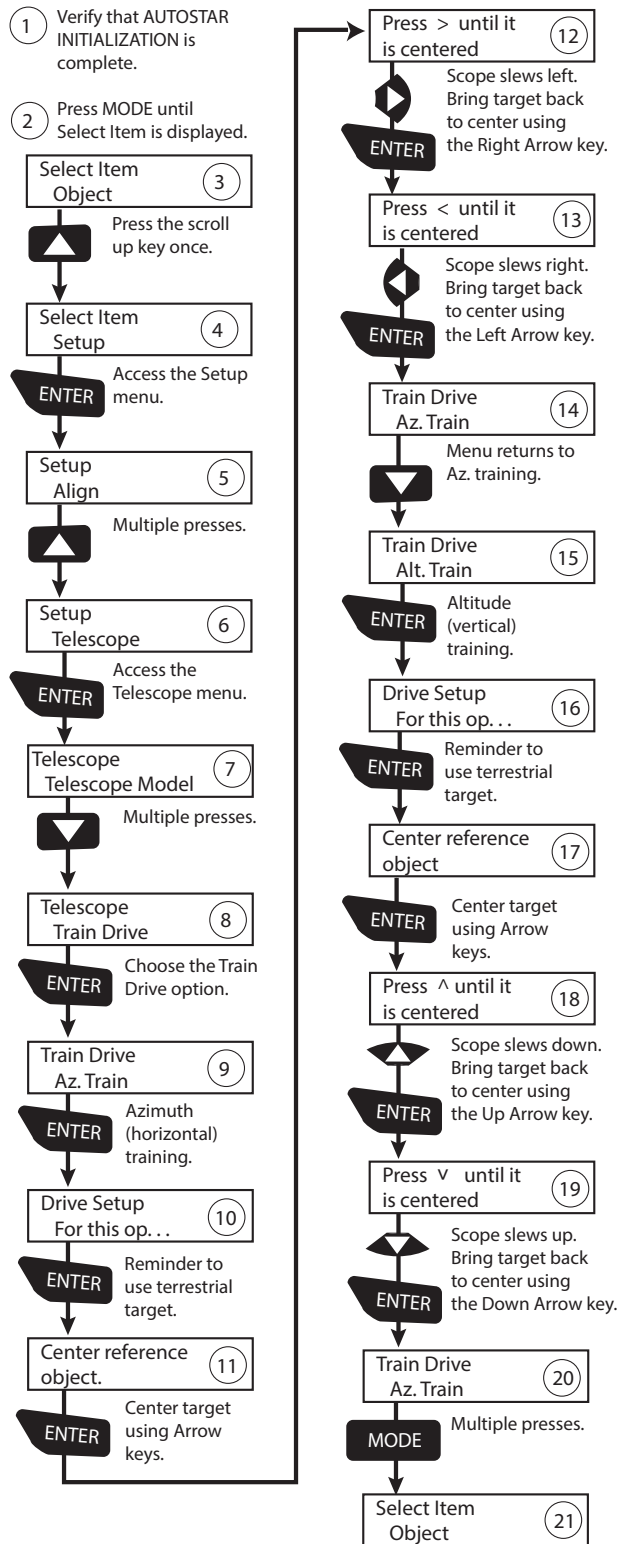

APPENDIX E:

Optical Designs

The Meade Advanced Coma-Free Optical System

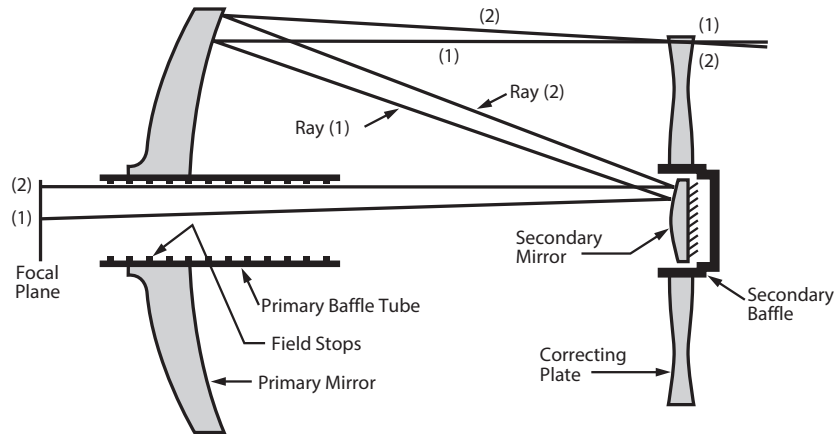

Unlike Schmidt-Cassegrain systems, Meade's Advanced Coma-Free (ACF) optical system provides razor-sharp pin-point star images all the way to the very edge of the field of view. This aplanatic (coma-free) optical system brings the highest level of performance to the amateur astronomer.

In the ACF design of the Meade LX85 telescope, light enters from the right, passes through a thin lens with 2-sided aspheric correction ("correcting plate"), proceeds to a spherical primary mirror, and then to a hyperbolic secondary mirror. The hyperbolic secondary mirror multiplies the effective focal length of the primary mirror and results in a focus at the focal plane, with light passing through a central perforation in the primary mirror.

All ACFs include oversize primary mirrors, yielding a fully illuminated field-of-view significantly wider than is possible with a standard-size primary mirror. Note that light ray (2) in the figure would be lost entirely, except for the oversize primary. It is this phenomenon which results in Meade ACF having off-axis field illuminations about 10% greater, aperture-for-aperture, than other systems utilizing standard-size primary mirrors. Field stops machined into the inside-diameter surface of the primary mirror baffle tube significantly increase lunar, planetary, and deep-space image contrast. These field stops effectively block off-axis stray light rays.

The Maksutov-Cassegrain Optical System

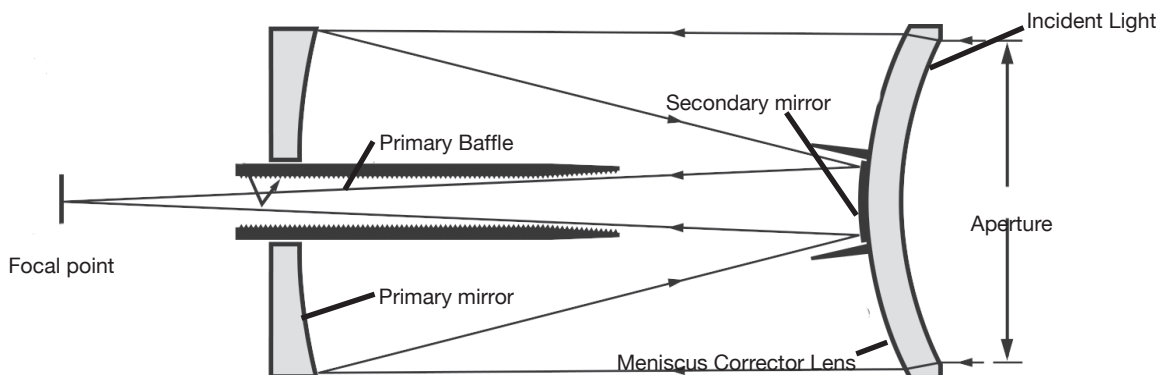

In the optical design of the Maksutov-Cassegrain, light enters from the right through a multi-coated meniscus lens, proceeds to an f/2.2 primary mirror, and then to a convex secondary mirror that multiplies effective focal length by a factor of 6.3. The secondary mirror light baffle, in combination with the anti-reflection threads inside the primary mirror baffle, produces extremely high contrast astronomical images at the focal plane.

The Refractor Optical System

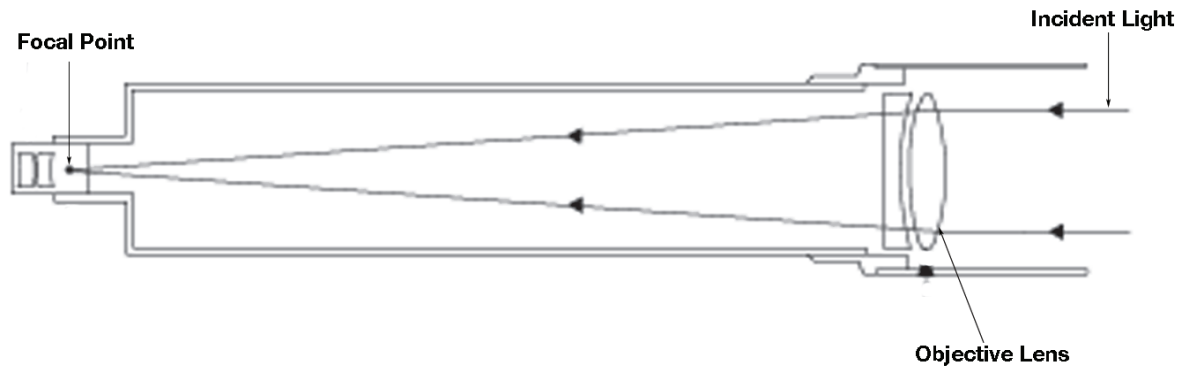

Refracting Telescopes use a large objective lens as their primary light-collecting element. Meade refractors include an achromatic (2-element) objective lenses in order to reduce, or virtually eliminate, the false color (chromatic aberration) that results in the telescopic image when light passes through a lens.

The Reflector Optical System

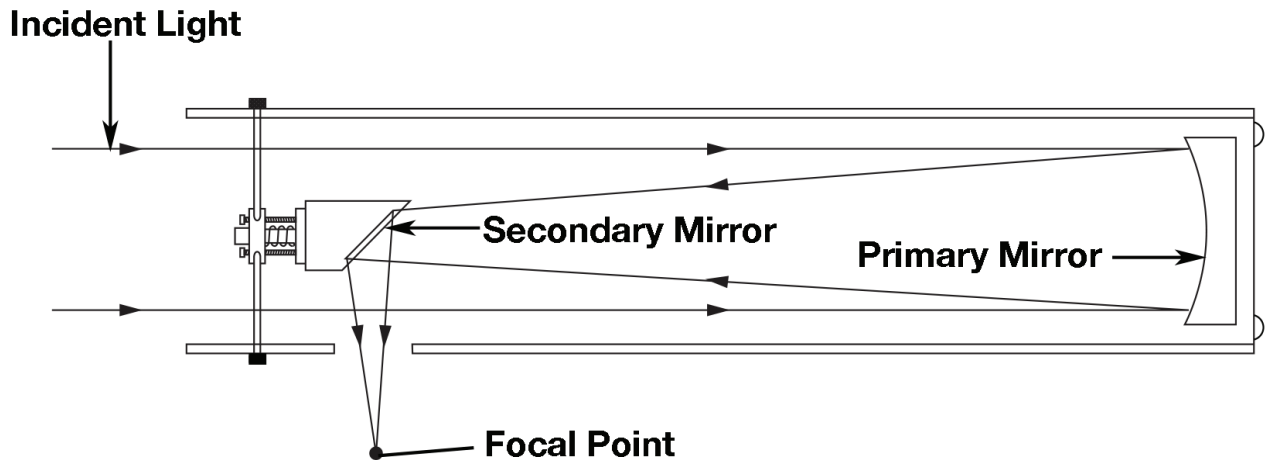

Reflector telescopes, also referred to as Newtonian Reflectors, crediting Isaac Newton for the invention of this telescope type, uses a concave primary mirror to gather light to a point of focus. All LX85 Reflectors use a parabolic-figured mirror, which corrects for spherical aberration inherent in other more standard reflector types that use a spherical mirror. The secondary mirror is a flat optical surface that directs the focal point to the side of the optical tube where the focuser and eyepiece are located. The design is simple, efficient, and often the most economic choice for larger aperture instruments.

APPENDIX F:

Collimating the Optics (for ACFs, Maksutov-Cassegrains and Reflectors)

The optics of your LX85 telescope have been collimated (aligned) at the factory. Ordinarily the telescope collimation should remain intact unless it is handled roughly in transport. Occasionally the alignment should be inspected and adjusted, when necessary, to retain the maximum optical performance of the telescope.

Collimating the Maksutov-Cassegrain Optical System

The only optical component that can be adjusted in your 6" Maksutov-Cassegrain is the tilt of the Primary Mirror. The front corrector and secondary mirror are permanently aligned. This makes collimation overall fairly straightforward. Follow these steps to inspect and adjust the alignment of your optical tube.

Collimate Using the Star Test

1. At night, point the telescope to a fairly bright star that is at least 60° above the horizon. This will ensure the star is above most of the turbulent layers of sky seen closer to the horizon. Allow the telescope to adjust to the temperature of your observation site before proceeding; temperature differences between the optics and the outside air can cause distortion in the images.

2. Center the star with the 26mm eyepiece, then switch to the 9mm eyepiece. We recommend powering on the LX85 and turning the tracking on so that you can keep the star centered during this process and easily re-

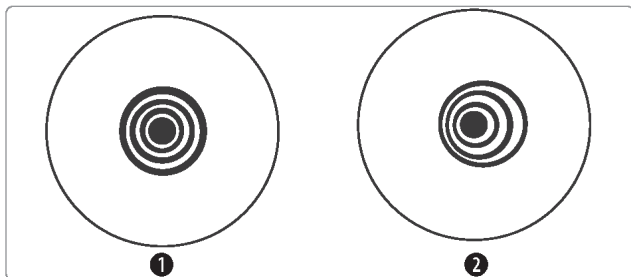

Figure 1. Correct (1) and incorrect (2) collimation as viewed during a star test.

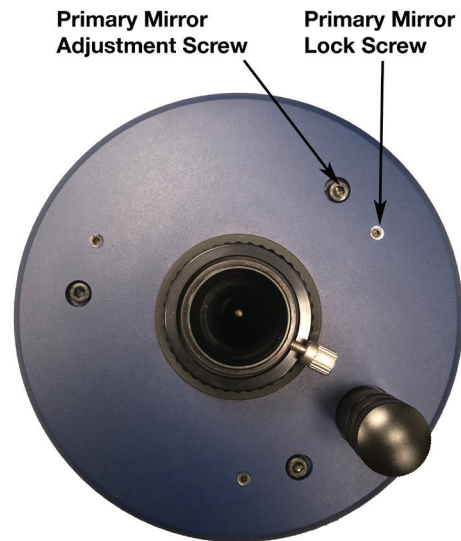

Figure 2.

center the star as needed with the AudioStar handbox.

Note: The star must be precisely centered in the eyepiece to accurately assess the collimation of the telescope.

3. Bring the star out of focus by about 1/2 turn on the focus knob. The defocused star pattern should look concentric, with the secondary mirror shadow centered to star pattern. Everything should look circular as it does in Figure 1. If the pattern is not concentric, or if it looks elliptical (2, Fig 1), you will need to make and adjustment to the primary mirror.

4. The primary mirror cell is adjusted using three adjustment screws and three locking screws. To collimate the primary mirror, first loosen each of the locking screws by turning them counterclockwise one full turn. Next make a small adjustment to the necessary adjustment screws and re-center the star in the eyepiece. Each adjustment screw can tilt the primary mirror and has limited range of adjustment. Using a 2.5mm and 4mm Allen wrench, make small adjustments until the defocused star image looks like "1" in Figure 1. When complete lightly tighten all three locking knobs to secure the mirror in place. Do not overtighten.

Collimating the ACF Optical System

The optical collimation (alignment) of any astronomical telescope used for serious purposes is important, but in the case of the Advanced Coma-Free (ACF)

system, such collimation is absolutely essential for good performance. Take special care to read and understand this section well so that your ACF will give you the best optical performance.

1. At night, point the telescope to a fairly bright star that is at least 60° above the horizon. This will ensure the star is above most of the turbulent layers of sky seen closer to the horizon. Allow the telescope to adjust to the temperature of your observation site before proceeding; temperature differences between the optics and the outside air can cause distortion in the images.

2. With the star centered, defocus the image gradually so that the defocused star looks like a ring of light surrounding a dark central spot; the dark central spot is the shadow of the secondary mirror. Turn the focus knob until the ring of light fills about 10% of the eyepiece field-diameter. If the dark central spot is offset in (i.e., not concentric with) the ring of light, your telescope's optical system is misaligned and requires collimation.

Follow these steps for collimation of the optical system:

- a. The only adjustments possible for the secondary mirror are located in the center of the secondary

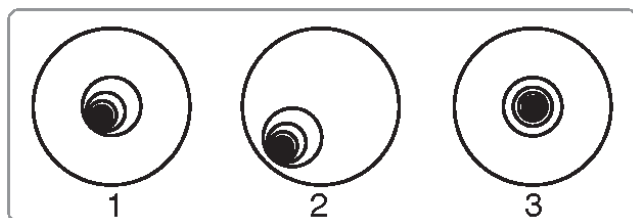

Figure 3a.

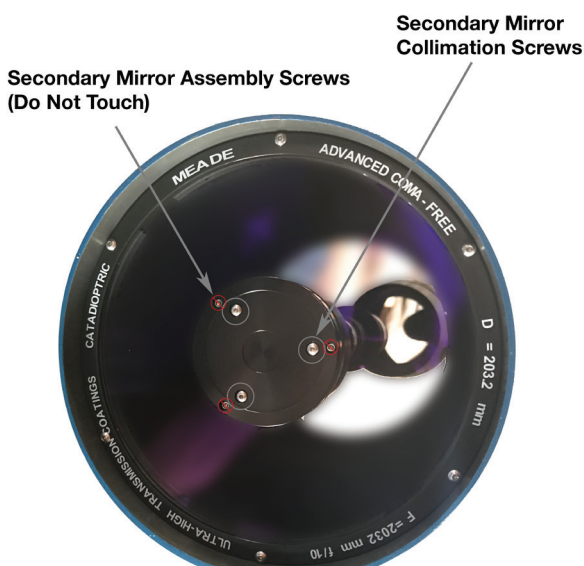

Figure 3b.

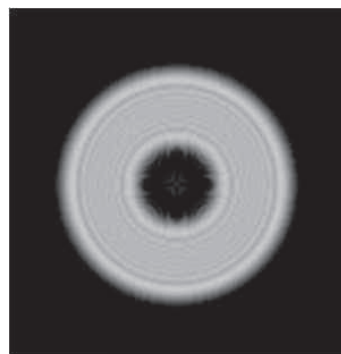

Figure 3c. Defocused star pattern in a properly collimated ACF system.

mirror housing. The outer screws should not be touched and hold the holder in place. Only make small adjustments to the inner three collimation screws.

Do not turn the screws past their normal travel and do not loosen them more than two full turns in a counterclockwise direction or the secondary mirror may come loose from its support. You will find that the adjustments are very sensitive, usually requiring only one-half turn or less to produce the desired result.

b. While looking at the defocused star image, notice which direction the darker shadow is offset in the ring of light or notice which part of the ring is the thinnest. Place your index finger in front of the telescope so that it touches one of the collimation set screws. You will see the shadow of your finger in the ring of light. Move your finger around the edge of the black plastic secondary mirror support until you see the shadow of the finger crossing the thinnest part of the ring of light. At this point, look at the front of the telescope where your finger is aiming. It will either be pointing directly at a set screw, or it will be between two set screws aiming at the set screw on the far side of the black plastic secondary mirror support. This is the set screw that you will adjust.

c. Using the AudioStar's Arrow keys at the slowest slew speed, move the defocused image to the edge of the eyepiece field of view (2, Fig. 3a), in the same direction as the darker shadow is offset in the ring of light.

d. Turn the set screw that you found with the pointing exercise while looking in the eyepiece. You will notice that the star image will move across the

field. If while turning the defocused star image flies out of the eyepiece field, then you are turning the screw the wrong way. Turn the opposite direction and bring the image back to the center of the field.

e. If the screw you are turning becomes very loose, tighten the other two screws by even amounts. If the screw you are turning gets too tight, unthread the other two by even amounts.

f. When you bring the image to center (Fig. 3a), carefully examine the evenness of the ring of light (concentricity, Figure 3c). If you find that the dark center is still off in the same direction, continue to make the adjustment in the original turning direction. If it is now off in the opposite direction, you have turned too far and you need to turn in the opposite direction. Always double check the image in the center of the field of the eyepiece.

g. You may find after your initial adjustment that the dark center is off in a new direction (e.g., instead of being off side-to-side it is now off in an up-and-down direction). In this case repeat steps b through f to find the new adjustment screw.

h. Now try a higher power eyepiece (e.g., 9mm or less) and repeat the above tests. Any lack of collimation at this point will require only very slight adjustments of the three set screws. You now have good collimation of the optics.

i. As a final check of alignment, examine the star image in focus with the higher power eyepiece as suggested (j), under good viewing conditions. The star point should appear as a small central dot (commonly referred to as an "Airy disc") with a diffraction ring surrounding it. To give a final precision collimation, make extremely slight adjustments of the three set screws, if necessary, to center the Airy disc in the diffraction ring. You now have the best alignment of the optics possible with this telescope.

Collimating Newtonian Reflector Optical System

(figures seen on page 56)

The optical systems of Newtonian Reflector telescopes include the following parts: primary mirror (1, Fig. 4); secondary mirror (2, Fig. 4); secondary mirror-holder (3, Fig. 4); secondary mirror-vanes (4, Fig. 4) and

(1, Fig. 5); primary mirror-tilt screws (5, Fig. 4). The telescope's image is brought to a focus at (6, Fig. 4).

1. Confirm alignment - To confirm optical alignment look down the focuser draw-tube (1, Fig. 7) with the eyepiece removed. The edge of the focuser drawtube frames reflections of the primary mirror (2, Fig. 7), the secondary mirror (3, Fig. 7), the three ("spider") vanes (4, Fig. 7) holding the secondary mirror, and the observer's eye (5, Fig. 7). With the optics properly aligned, all of these reflections appear concentric (centered), as shown in Fig. 37. Any deviation from concentricity of any of these telescope parts with the eye requires adjustments to the secondary mirror-holder (Fig. 5) and/or the primary mirror cell (Fig. 6, as described below.

Secondary mirror-vane adjustments: If the secondary mirror (1, Fig. 8) is left or right of center within the drawtube (2, Fig. 8), slightly loosen the 3-vane adjustment/lock knobs (1, Fig. 5) located on the outside surface of the main tube and slide the entire secondary mirror-holder system up or down in the slotted holes of the main tube until the secondary mirror is centered in the drawtube. If the secondary mirror (1, Fig. 8) is above- or below-center within the drawtube, thread inward one of the adjustment/lock knobs (1, Fig. 5) while unthreading another of these knobs. Only make adjustments to two knobs at a time until the secondary mirror appears as in Fig. 9.

2. Secondary mirror-holder adjustments: If the secondary mirror (1, Fig. 9) is centered in the focuser drawtube (2, Fig. 9), but the primary mirror is only partially visible in the reflection (3, Fig. 9), the three "+" (Phillips head) secondary mirror-tilt screws (2, Fig. 5) should be slightly unthreaded to the point where the secondary mirror-holder (3, Fig. 5) can rotate about its axis parallel to the main tube. Grasp the secondary mirror-holder (avoid touching the mirror surface!) with your hand and rotate it until, looking through the drawtube, you can see the primary mirror centered as well as possible in the reflection of the secondary mirror. With the rotation of the secondary mirror-holder at this best-possible position, thread in the three Phillips head screws (2, Fig. 5) to lock the rotational position. Then, if necessary, make adjustments to these three Phillips head screws to refine the tilt-angle of the secondary mirror, until the entire primary mirror can be seen centered within the secondary mirror's

reflection. With the secondary mirror thus aligned the image through the drawtube appears as in Fig. 10.

3. Primary mirror adjustments: If the secondary mirror (1, Fig. 10) and the reflection of the primary mirror (2, Fig. 10) appear centered within the drawtube (3, Fig. 10), but the reflection of your eye and the reflection of the secondary mirror (4, Fig. 10) appear off-center, then the primary mirror tilt requires adjusting, using the Phillips head screws of the primary mirror cell (3, Fig. 6). These primary mirror-tilt screws are located behind the primary mirror, at the lower end of the main tube. See Fig. 6. Before adjusting the primary mirror-tilt screws, first unscrew by several turns (use either a hex wrench or pliers) the three hex-head primary mirror lock screws (2, Fig. 6) which are also located on the rear surface of the primary mirror cell and which alternate around the cell's circumference with the three Phillips head screws. Then by trial and error turn the primary mirror Phillips head tilt screws (3, Fig. 6) until you develop a feel for which way to turn each screw to center the reflection of your eye in the drawtube. (An assistant is helpful in this operation.) With your eye centered as shown in Fig. 7, turn the three hex head primary mirror lock screws (2, Fig. 6) to re-lock the tilt-angle of the primary mirror.

The telescope's optical system is now aligned. This collimation should be checked from time to time, with small adjustments (per steps 1, 2, and/or 3, above) effected as required to keep the optics well-aligned.

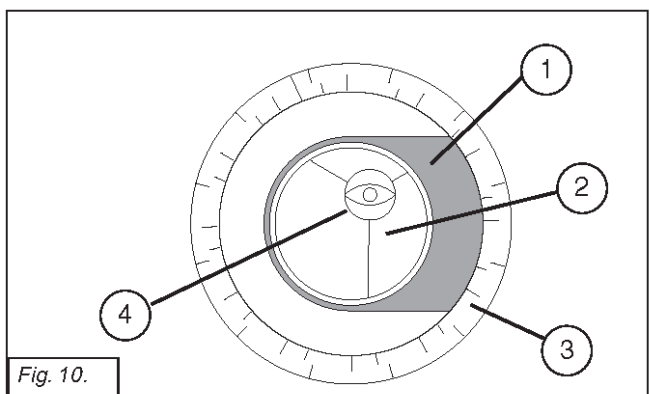
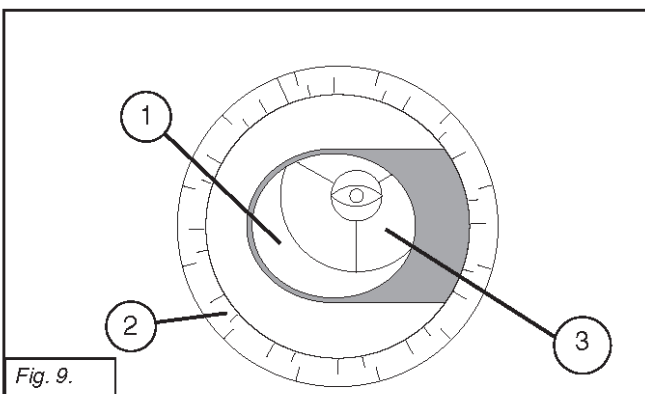
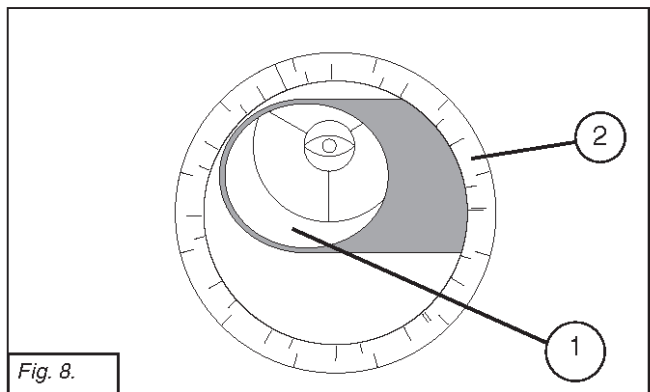
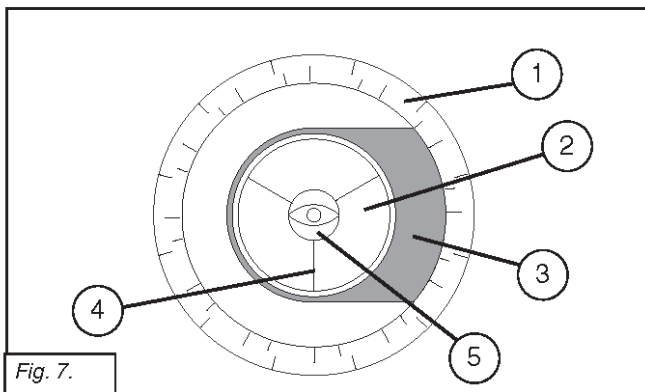
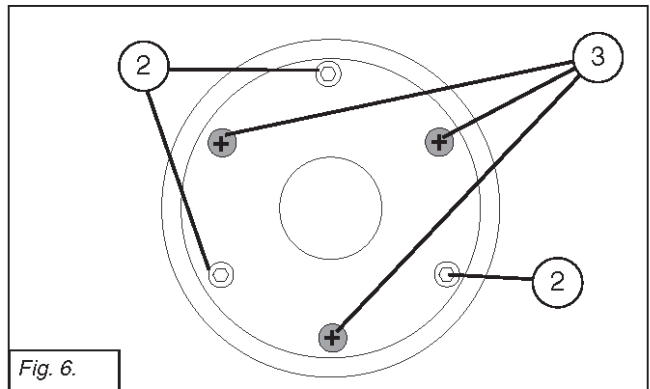
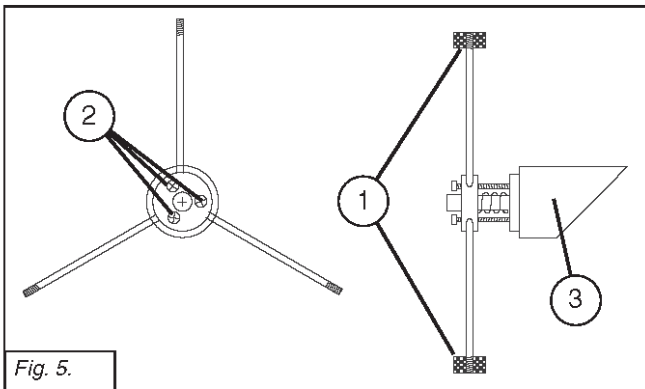
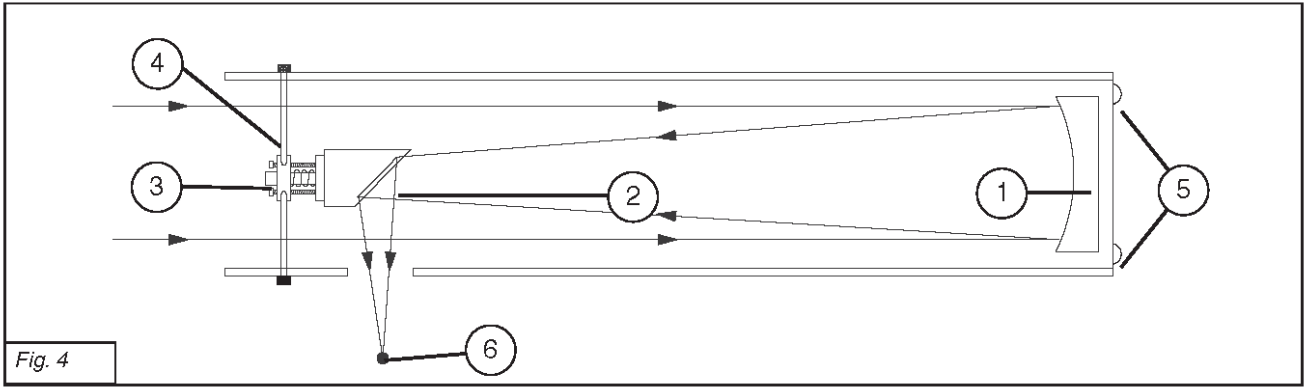

APPENDIX G:

Table of Latitudes

Latitude Chart for Major Cities of the World

To aid in the polar alignment procedure (see page 45), latitudes of major cities around the world are listed below. To determine the latitude of an observing site not listed on the chart, locate the city closest to your site. Then follow the procedure below:

Northern hemisphere observers (N): If the site is over 70 miles (110 km) North of the listed city, add one degree for every 70 miles. If the site is over 70 miles South of the listed city, subtract one degree per 70 miles.

Southern Hemisphere observers (S): If the site is over 70 miles (110 km) North of the listed city, subtract one degree for every 70 miles. If the site is over 70 miles South of the listed city, add one degree per 70 miles.

NORTH AMERICA			EUROPE (continued)		
City	State/Prov./Country	Latitude	City	Country	Latitude
Albuquerque	New Mexico	35° N	Oslo	Norway	60° N
Anchorage	Alaska	61° N	Paris	France	49° N
Atlanta	Georgia	34° N	Rome	Italy	42° N
Boston	Massachusetts	42° N	Stockholm	Sweden	59° N
Calgary	Alberta	51° N	Vienna	Austria	48° N
Chicago	Illinois	42° N	Warsaw	Poland	52° N
Cleveland	Ohio	41° N	SOUTH AMERICA		
Dallas	Texas	33° N	City	Country	Latitude
Denver	Colorado	40° N	Bogotá	Colombia	4° N
Detroit	Michigan	42° N	São Paulo	Brazil	23° S
Honolulu	Hawaii	21° N	Buenos Aires	Argentina	35° S
Jackson	Mississippi	32° N	Montevideo	Uruguay	35° S
Kansas City	Missouri	39° N	Santiago	Chile	34° S
Kenosha	Wisconsin	45° N	Caracas	Venezuela	10° N
Las Vegas	Nevada	36° N	ASIA		
Little Rock	Arkansas	35° N	City	Country	Latitude
Los Angeles	California	34° N	Beijing	China	40° N
Mexico City	Mexico	19° N	Hong Kong	China	23° N
Miami	Florida	26° N	Seoul	South Korea	37° N
Minneapolis	Minnesota	45° N	Taipei	Taiwan	25° N
Nashville	Tennessee	36° N	Tokyo	Japan	36° N
New Orleans	Louisiana	30° N	Sapporo	Japan	43° N
New York	New York	41° N	Bombay	India	19° N
Oklahoma City	Oklahoma	35° N	Calcutta	India	22° N
Ottawa	Ontario	45° N	Hanoi	Vietnam	21° N
Philadelphia	Pennsylvania	40° N	Jedda	Saudi Arabia	21° N
Phoenix	Arizona	33° N	AFRICA		
Portland	Oregon	46° N	City	Country	Latitude
Salt Lake City	Utah	41° N	Cairo	Egypt	30° N
San Antonio	Texas	29° N	Cape Town	South Africa	34° S
San Diego	California	33° N	Rabat	Morocco	34° N
San Francisco	California	38° N	Tunis	Tunisia	37° N
Seattle	Washington	47° N	Windhoek	Namibia	23° S
Washington	District of Columbia	39° N	AUSTRALIA AND OCEANIA		
EUROPE			City	State/Country	Latitude
City	Country	Latitude	Adelaide	South Australia	35° S
Amsterdam	Netherlands	52° N	Brisbane	Queensland	27° S
Athens	Greece	38° N	Canberra	New South Wales	35° S
Bern	Switzerland	47° N	Alice Springs	Northern Territory	24° S
Copenhagen	Denmark	56° N	Hobart	Tasmania	43° S
Dublin	Ireland	53° N	Perth	Western Australia	32° S
Frankfurt	Germany	50° N	Sydney	New South Wales	34° S
Glasgow	Scotland	56° N	Melbourne	Victoria	38° S
Helsinki	Finland	60° N	Auckland	New Zealand	37° S
Lisbon	Portugal	39° N			
London	England	51° N			
Madrid	Spain	40° N			

RECYCLING INFORMATION

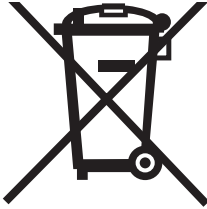

(EU Countries only)

Correct Disposal of this Product

(Waste Electrical & Electronic Equipment)

This marking shown on the product or its literature indicates that it must not be disposed of in unsorted municipal waste at the end of its working life

To prevent possible harm to the environment or human health from uncontrolled waste disposal, please separate this from other types of wastes and recycle it as required by law. Household users should contact either the retailer where they purchased this product, or their local government office, for details of where and how they can take this item for environmentally safe recycling. Business users should contact their supplier and check the terms and conditions of the purchase contract. This product should not be mixed with other commercial wastes for disposal.

Meade Limited Warranty

Every Meade telescope, spotting scope, and telescope accessory is warranted by Meade Instruments Corp (“Meade”) to be free of defects in materials and workmanship for a period of ONE YEAR from the date of original purchase in the U.S.A. and Canada. Meade will repair or replace a product, or part thereof, found by Meade to be defective, provided the defective part is returned to Meade, freight-prepaid, with proof of purchase. This warranty applies to the original purchaser only and is non-transferable. Meade products purchased outside North America are not included in this warranty, but are covered under separate warranties issued by Meade international distributors.

RGA Number Required: Prior to the return of any product or part, a Return Goods Authorization (RGA) number **must** be obtained from Meade by writing, or by calling (800) 626-3233. Each returned part or product must include a written statement detailing the nature of the claimed defect, as well as the owner’s name, address, and phone number.

This warranty is not valid in cases where the product has been abused or mishandled, where unauthorized repairs have been attempted or performed, or where depreciation of the product is due to normal wear-and-tear. Meade specifically disclaims special, indirect, or consequential damages or lost profit which may result from a breach of this warranty. Any implied warranties which cannot be disclaimed are hereby limited to a term of one year from the date of original retail purchase.

This warranty gives you specific rights. You may have other rights which vary from state to state.

Meade reserves the right to change product specifications or to discontinue products without notice.

This warranty supersedes all previous Meade product warranties.



We appreciate your business. Keep in touch!



@meadeinstruments



Let's get social:
@meadeinstruments



@meadeinstrument

Share your photos with us:

#MeadeMoments
Social@meade.com

For special offers and other products, visit our website
www.meade.com

1-800-626-3233
Meade Instruments
27 Hubble
Irvine, CA 92618



MEADE®

27 Hubble, Irvine, California 92618
(800) 626-3233 ■ www.meade.com

July 2018 REV 0
14-2720-00